



ΠΑΝΕΠΙΣΤΗΜΙΟ ΑΙΓΑΙΟΥ

Σχεδίαση με Η/Υ

Ενότητα 3: Αντίστροφη Μηχανική

Φίλιππος Αζαριάδης
Τμήμα Μηχανικών Σχεδίασης
Προϊόντων και Συστημάτων

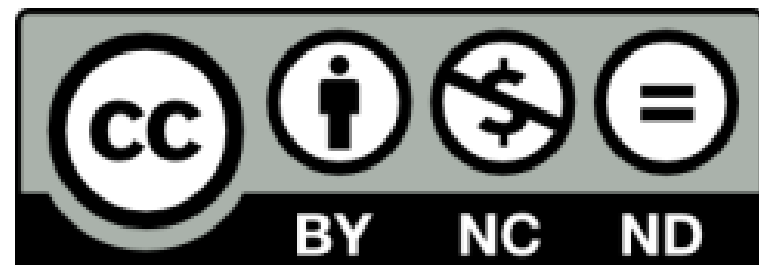

Ευρωπαϊκή Ένωση
Ευρωπαϊκό Κοινωνικό Ταμείο



ΥΠΟΥΡΓΕΙΟ ΠΑΙΔΕΙΑΣ & ΘΡΗΣΚΕΥΜΑΤΩΝ, ΠΟΛΙΤΙΣΜΟΥ & ΑΘΛΗΤΙΣΜΟΥ
ΕΙΔΙΚΗ ΥΠΗΡΕΣΙΑ ΔΙΑΧΕΙΡΙΣΗΣ

Με τη συγχρηματοδότηση της Ελλάδας και της Ευρωπαϊκής Ένωσης



Άδειες Χρήσης

- Το παρόν εκπαιδευτικό υλικό υπόκειται σε άδειες χρήσης Creative Commons.
- Για εκπαιδευτικό υλικό, όπως εικόνες, που υπόκειται σε άλλου τύπου άδειας χρήσης, η άδεια χρήσης αναφέρεται ρητώς.



Χρηματοδότηση

- Το παρόν εκπαιδευτικό υλικό έχει αναπτυχθεί στα πλαίσια του εκπαιδευτικού έργου του διδάσκοντα.
- Το έργο «**Ανοικτά Ακαδημαϊκά Μαθήματα στο Πανεπιστήμιο Αιγαίου**» έχει χρηματοδοτήσει μόνο τη αναδιαμόρφωση του εκπαιδευτικού υλικού.
- Το έργο υλοποιείται στο πλαίσιο του Επιχειρησιακού Προγράμματος «Εκπαίδευση και Δια Βίου Μάθηση» και συγχρηματοδοτείται από την Ευρωπαϊκή Ένωση (Ευρωπαϊκό Κοινωνικό Ταμείο) και από εθνικούς πόρους.



Ευρωπαϊκή Ένωση
Ευρωπαϊκό Κοινωνικό Ταμείο



ΥΠΟΥΡΓΕΙΟ ΠΑΙΔΕΙΑΣ & ΘΡΗΣΚΕΥΜΑΤΩΝ, ΠΟΛΙΤΙΣΜΟΥ & ΑΘΛΗΤΙΣΜΟΥ
ΕΙΔΙΚΗ ΥΠΗΡΕΣΙΑ ΔΙΑΧΕΙΡΙΣΗΣ

Με τη συγχρηματοδότηση της Ελλάδας και της Ευρωπαϊκής Ένωσης



ΕΥΡΩΠΑΪΚΟ ΚΟΙΝΩΝΙΚΟ ΤΑΜΕΙΟ



Reverse Engineering of 3D Objects

Philip Azariadis

www.syros.aegean.gr/users/azar

Reverse engineering

- In product design a concept is transformed into a real part or object.
- In Reverse Engineering (RE) real products or objects are transformed into engineering models and concepts¹.
- Why RE?
 - To take advantage of the enormous benefits of CAD/CAE for a product design or re-design.
- When RE?
 - When no original drawing or documentation exist for an existing product.
 - When a part requires to be re-engineered and new analysis and modifications are required to construct an improved product.
 - In areas where aesthetic design is of particular important (e.g. automobile industry) and real wood or clay models are the outcome of a stylist work.
 - To generate custom fits to human surfaces for apparel design or the construction of medical implants.

Reverse engineering

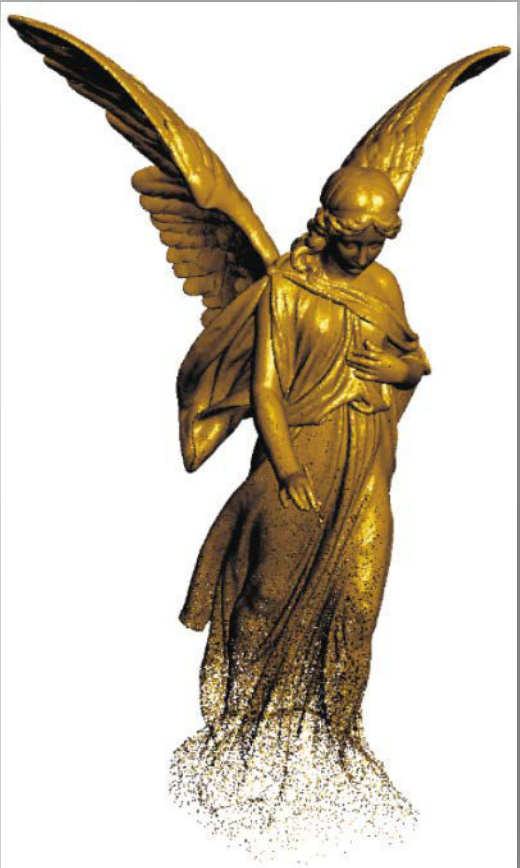
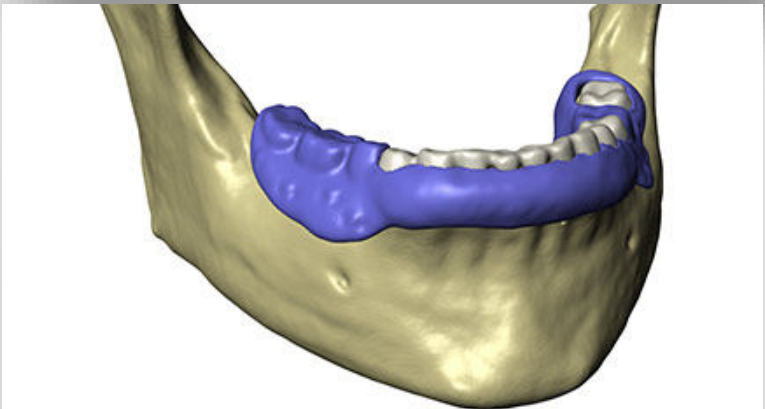
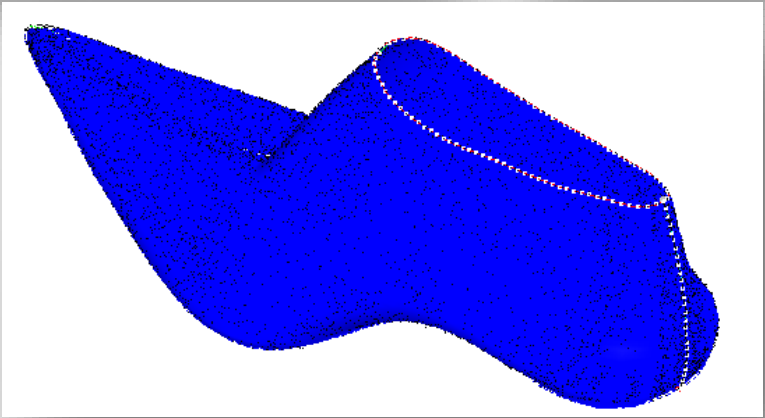
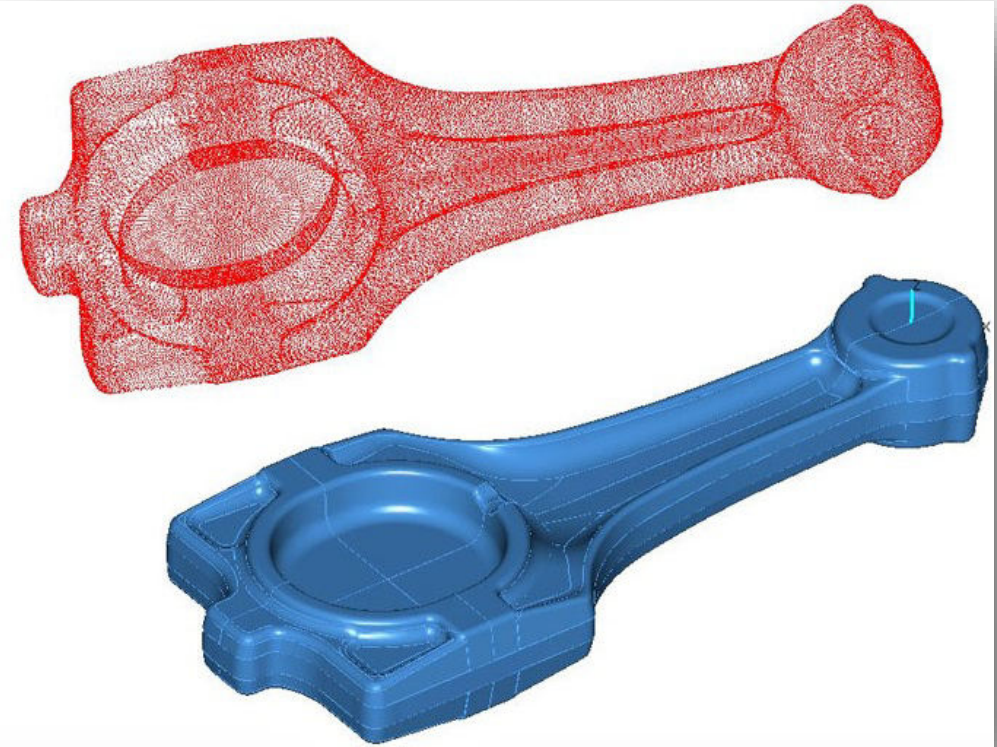
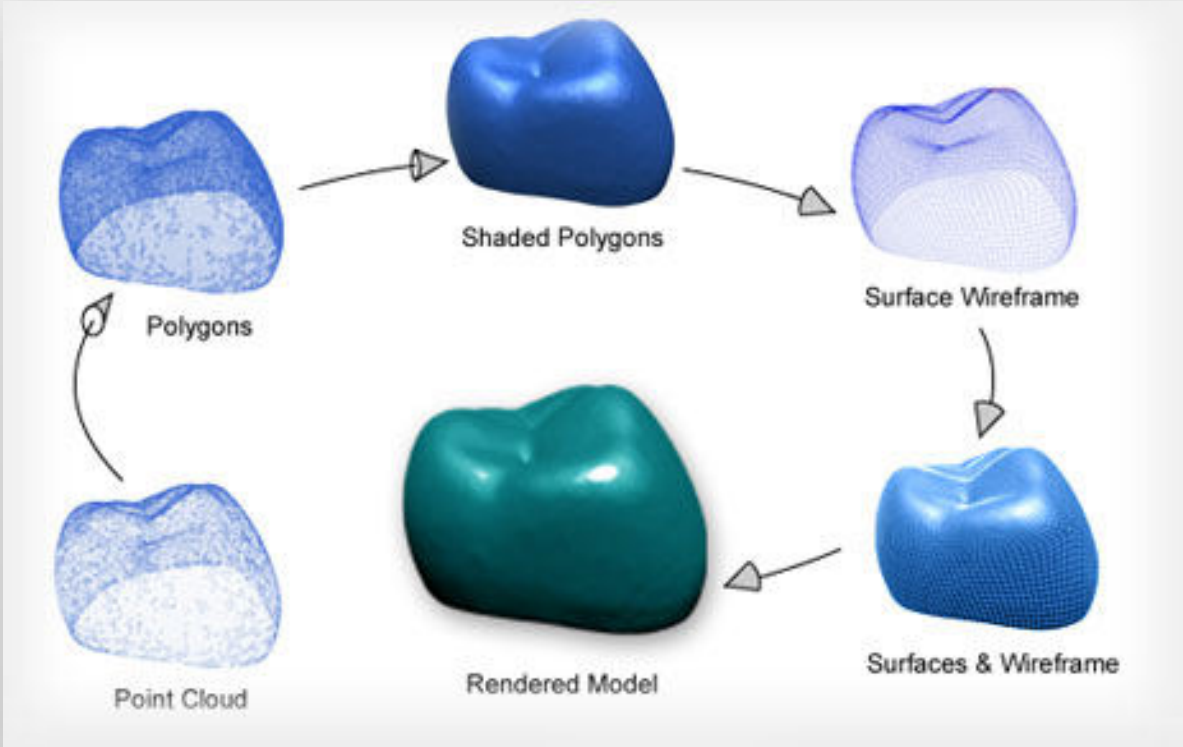

Reverse engineering: basic phases

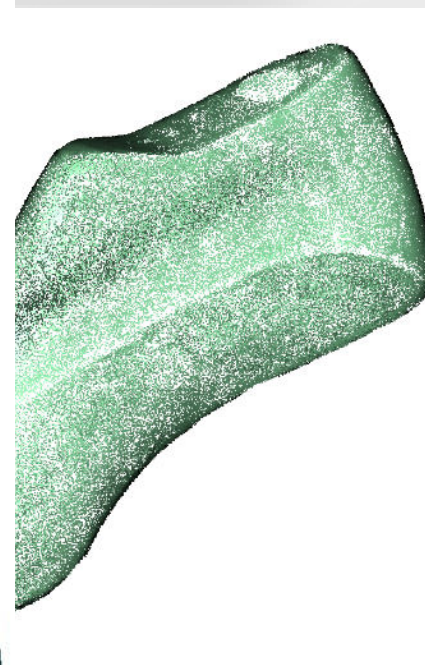
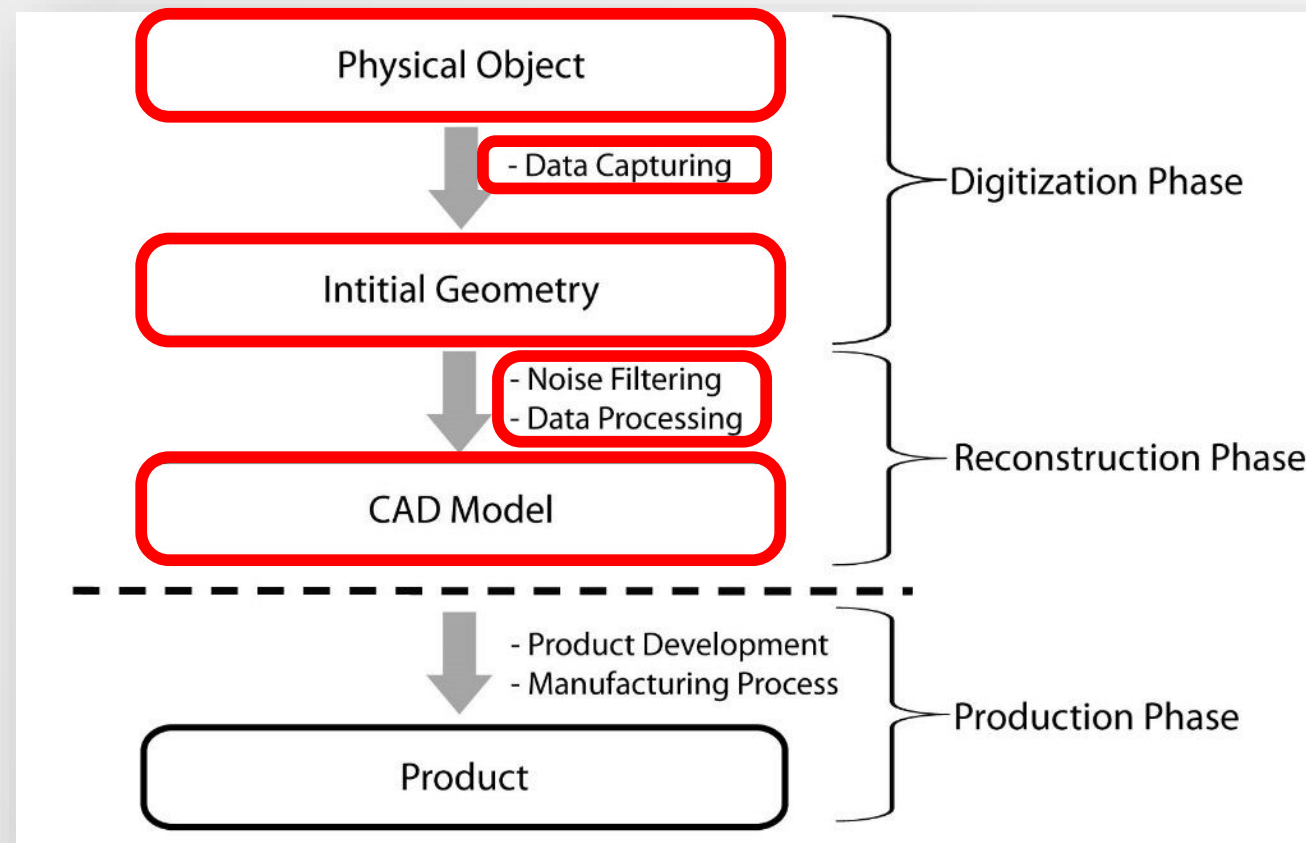

Data Capturing

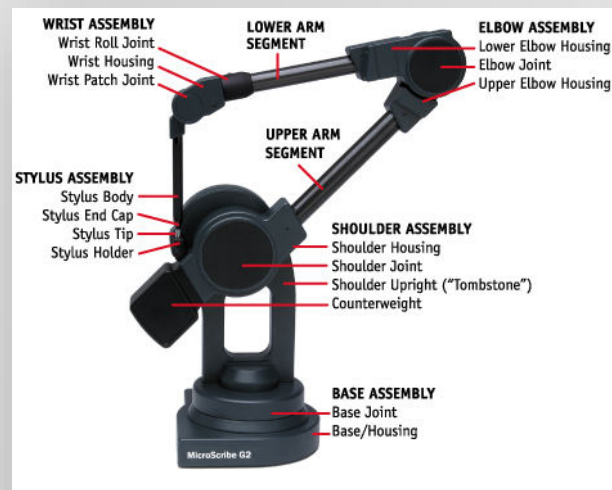
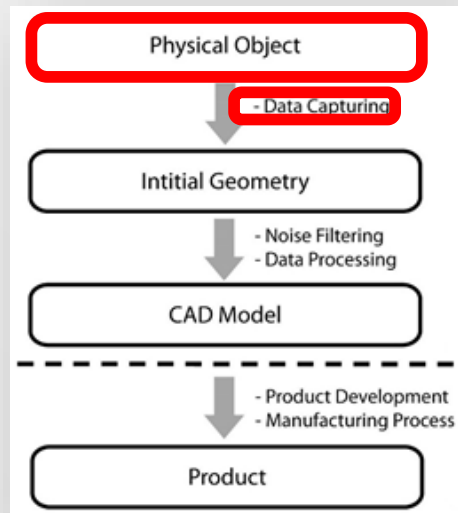

Data acquisition methods

~~Non-contact methods~~

Tactile methods

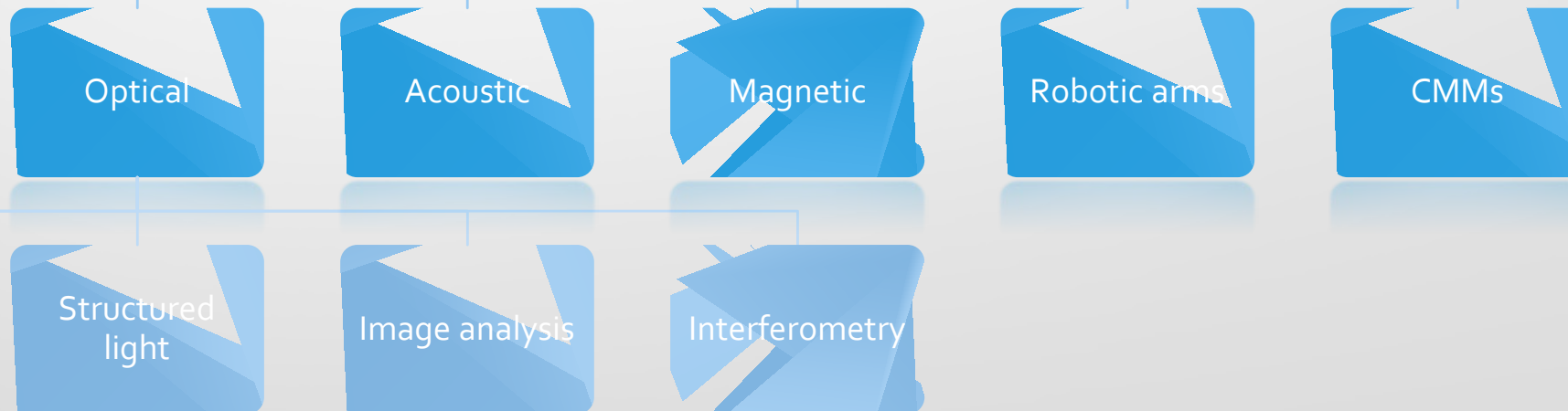

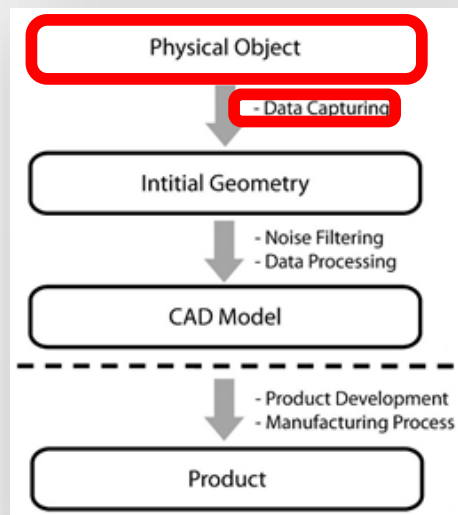

Data Capturing: optical

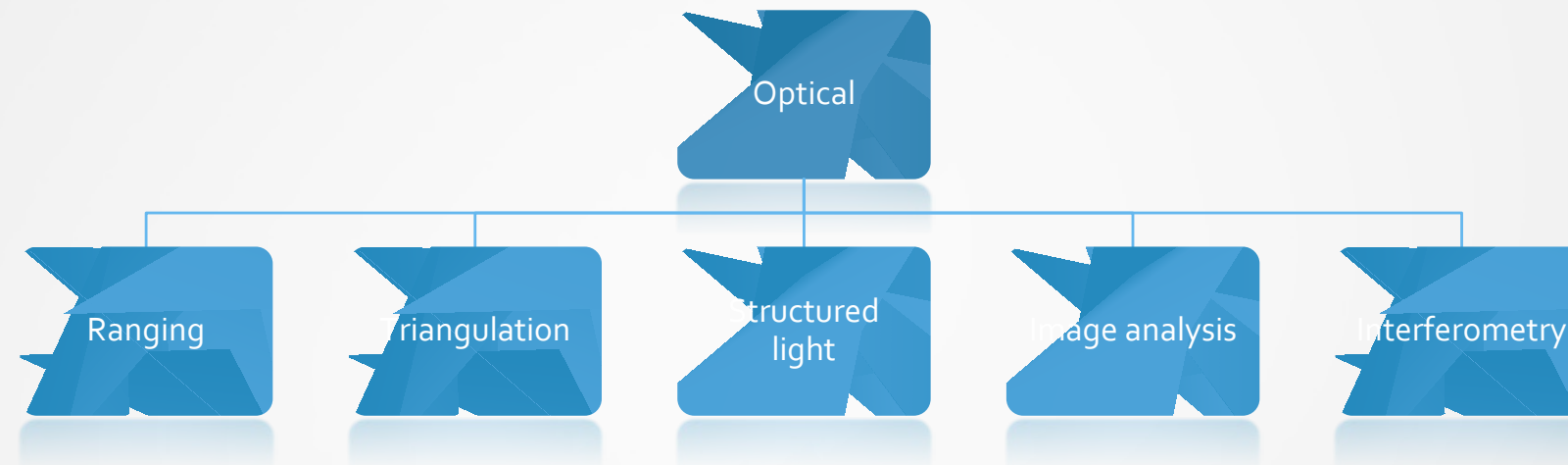

- **Optical methods** are the broadest and most popular, and offer high acquisition rates.
- Most important methods/technologies are: Triangulation, Ranging, Image analysis, Structured light and Interferometry.

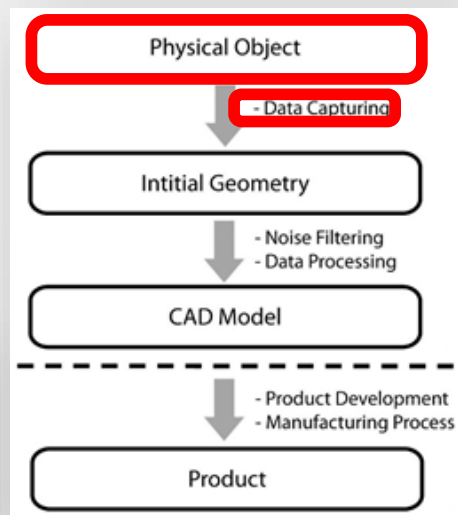

Data Capturing: optical

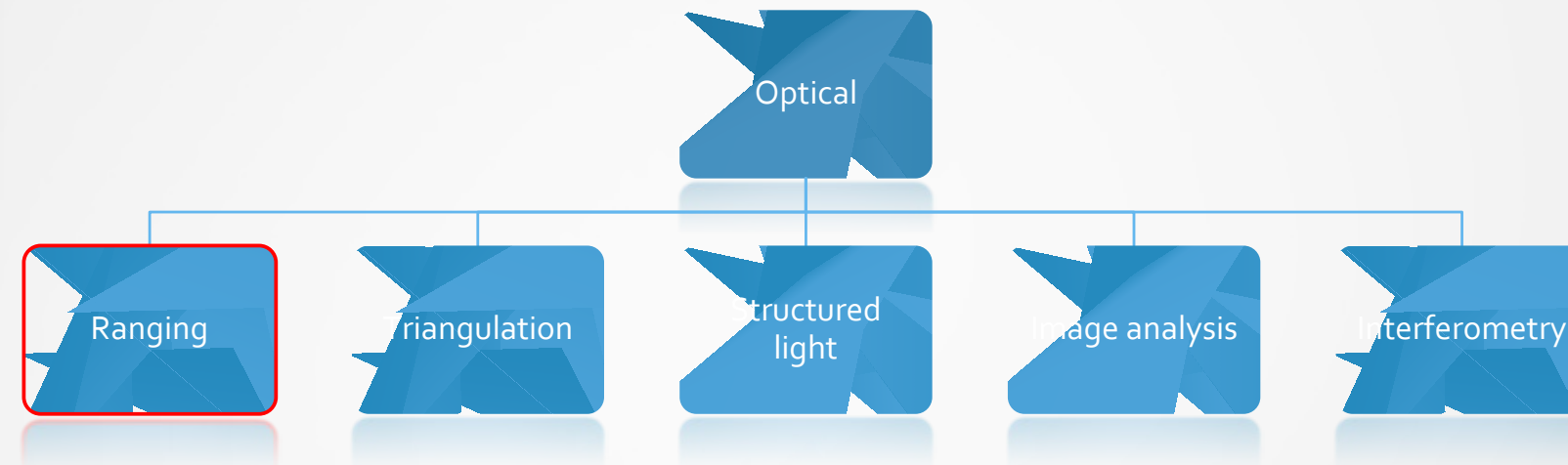

- **A range or time-to-flight** scanner uses a laser beam to probe the surface of an object.
- A laser device is used to emit a pulse of light and the amount of time before the reflected light is seen by a detector is measured. Since the speed of light is known, the round-trip time determines the travel distance of the light, which is twice the distance between the scanner and the surface.
- The accuracy of a time-of-flight 3D laser scanner depends on how precisely we can measure the time.
- The laser rangefinder only detects the distance of one point in its direction of view. Thus, the scanner scans its entire field of view one point at a time by changing the range finder's direction of view to scan different points.
- Typical time-of-flight 3D laser scanners can measure the distance of 10,000~100,000 points every second.

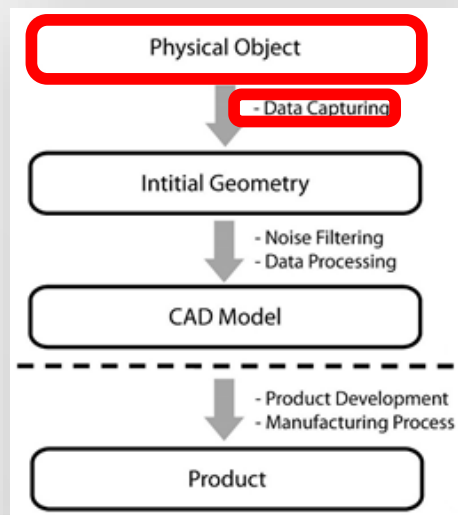

Data Capturing: optical

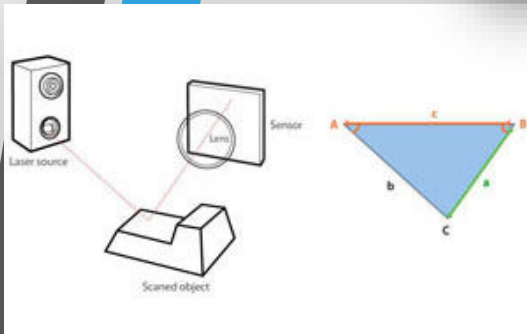
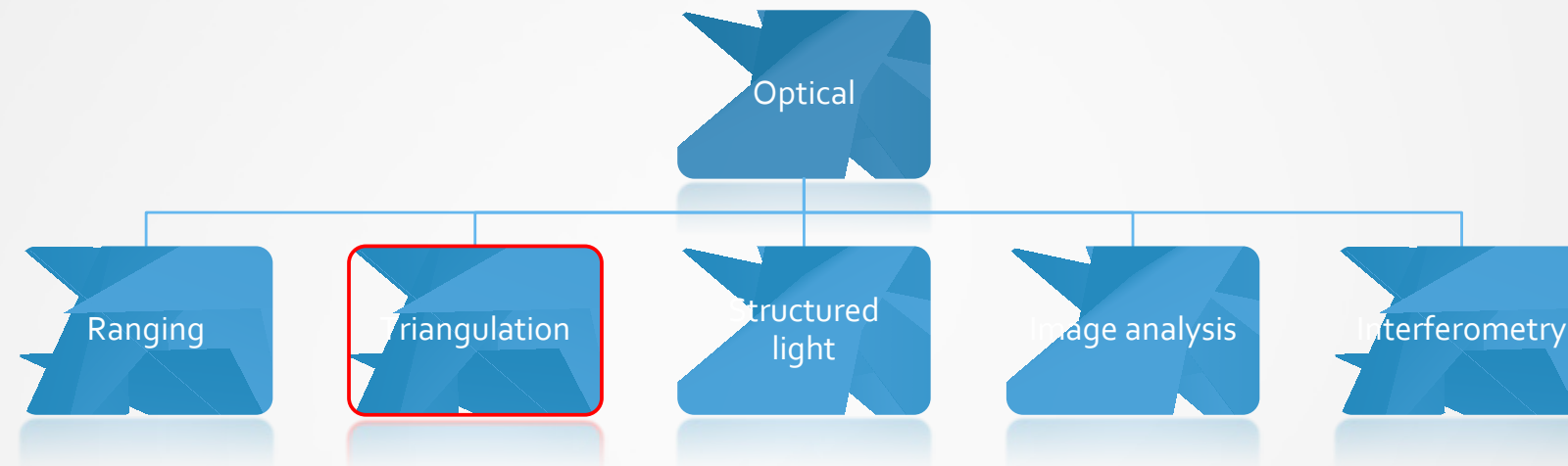

- **A laser device emits a high-energy light and a camera device is sensing the reflection of the light on the surface of the object.**
- The laser emitter, the location point and the camera define a triangle² that we are able to measure with high accuracy.
- Although different light sources have been tested, lasers are the most commonly used.
- Pros: available in many forms (e.g., handheld or portable arm), less part preparations are needed, less sensitive to ambient light. Good for short range scans (<1 m).

Cons: less accurate than range lasers.

Data Capturing: optical

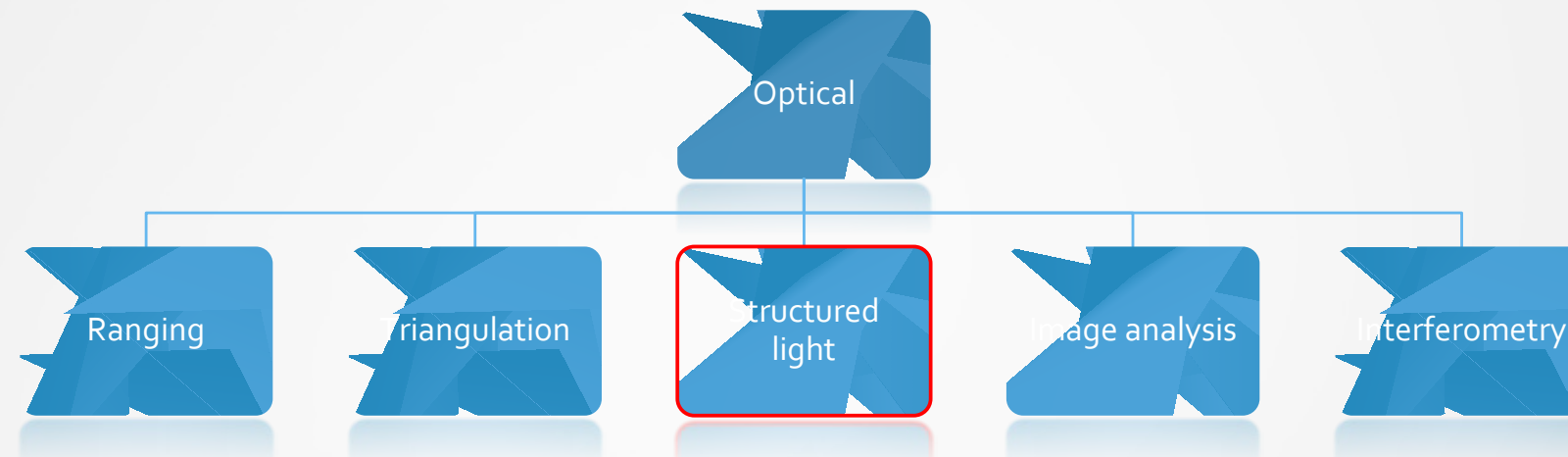
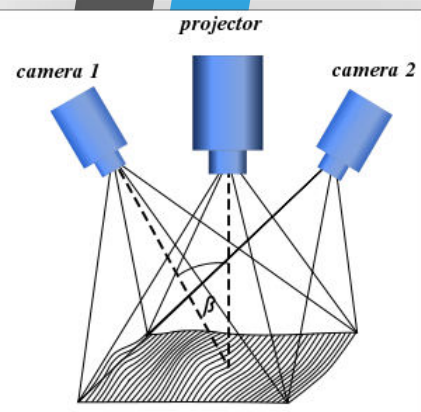
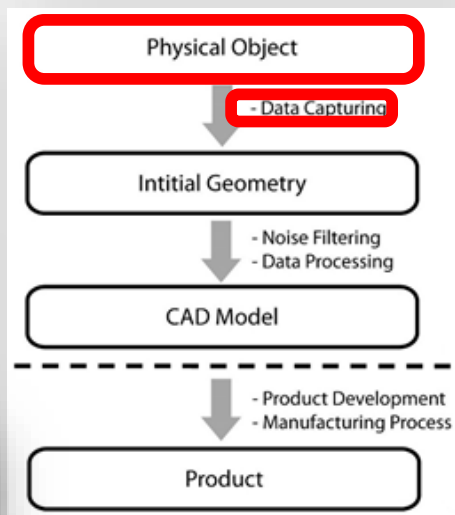

- **Structured lighting involves projecting patterns of light onto the surface of the object and capturing the image of the resulting pattern as reflected by the surface.**
- The light pattern is generated by a laser interference method with two wide planar laser beam fronts. Their interference results in regular, equidistant line patterns.
- A set of cameras and complex algorithms are utilized to determine the distances between the edges of the resulting pattern (a function of height). With these calculations the reflected pattern can be determined as a 3D surface.
- Pros: They can capture large amounts of data in a single image frame, provide higher accuracy compared to triangulation.
- Cons: They require heavy calculations to deduce the 3D surface coordinates, sensitive to ambient light, usually require object preparation.

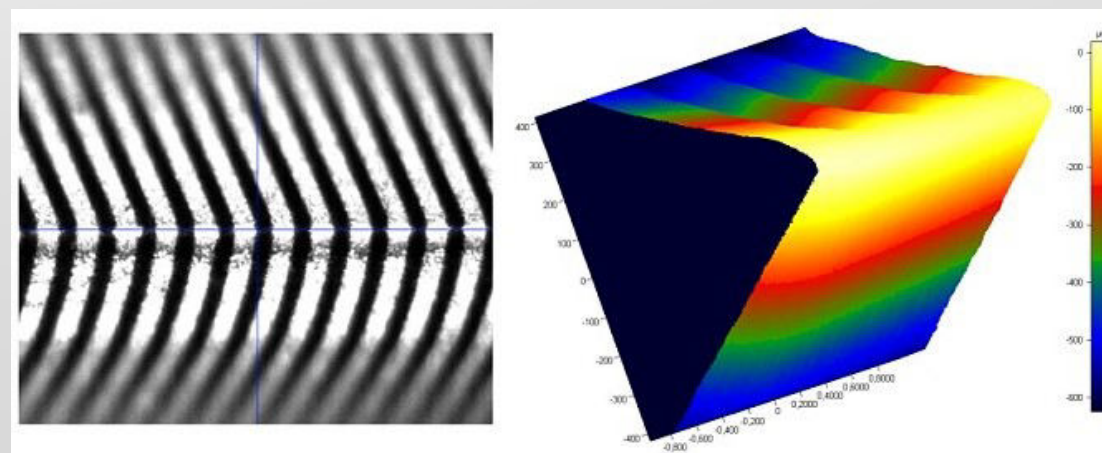
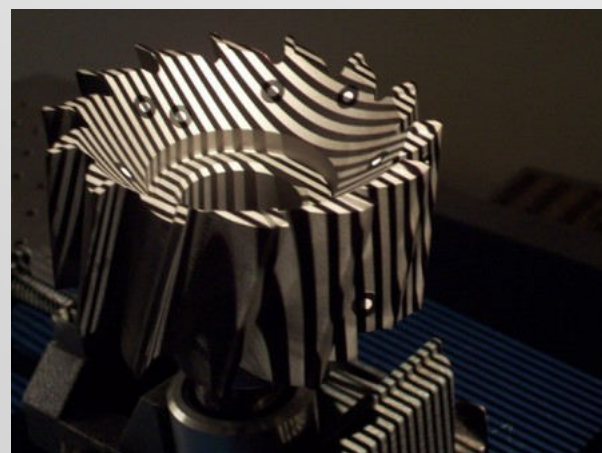

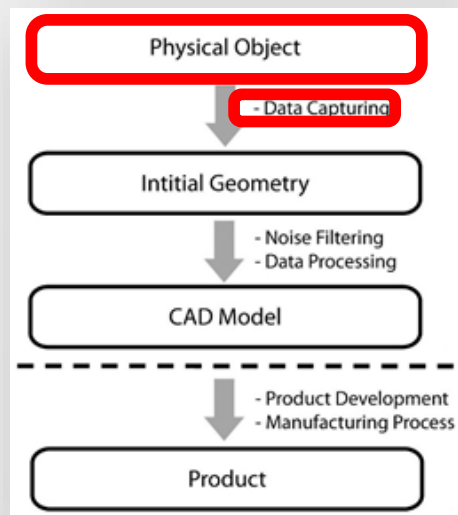

Data Capturing: optical

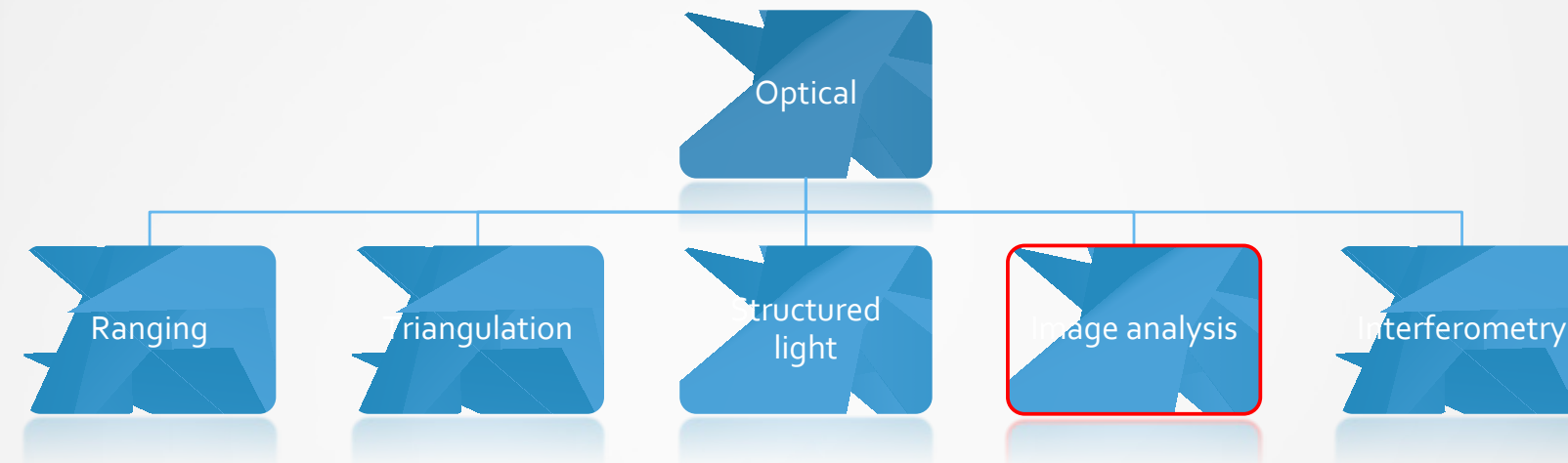

- **Stereo pairs with enough information are analyzed to provide surface height and coordinates.**
- Passive: when no structure lighting is used.
- Active: artificial lighting is used in the acquisition of data.
- Also, known as “stereo imaging” methods and they are close related with “stereoscopy”.

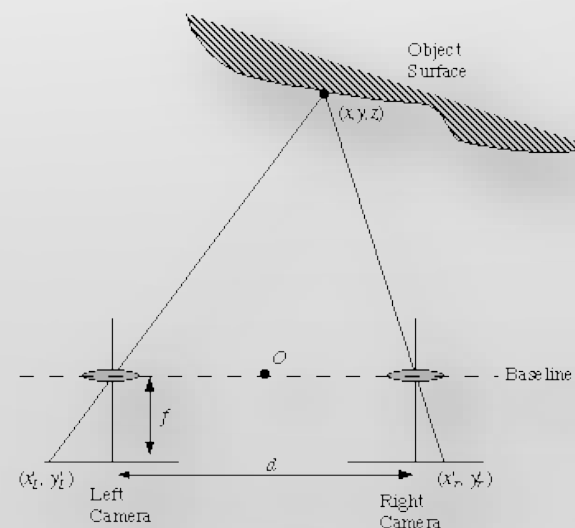

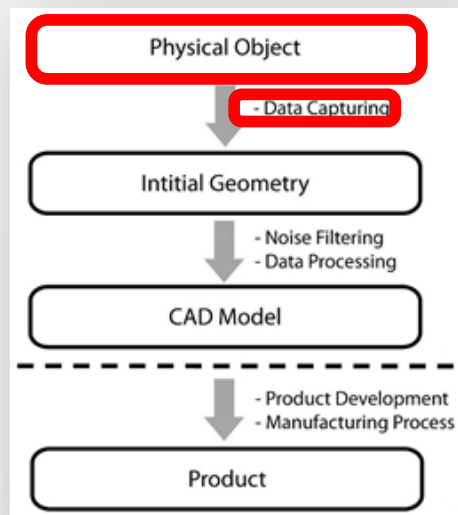

Data Capturing: optical

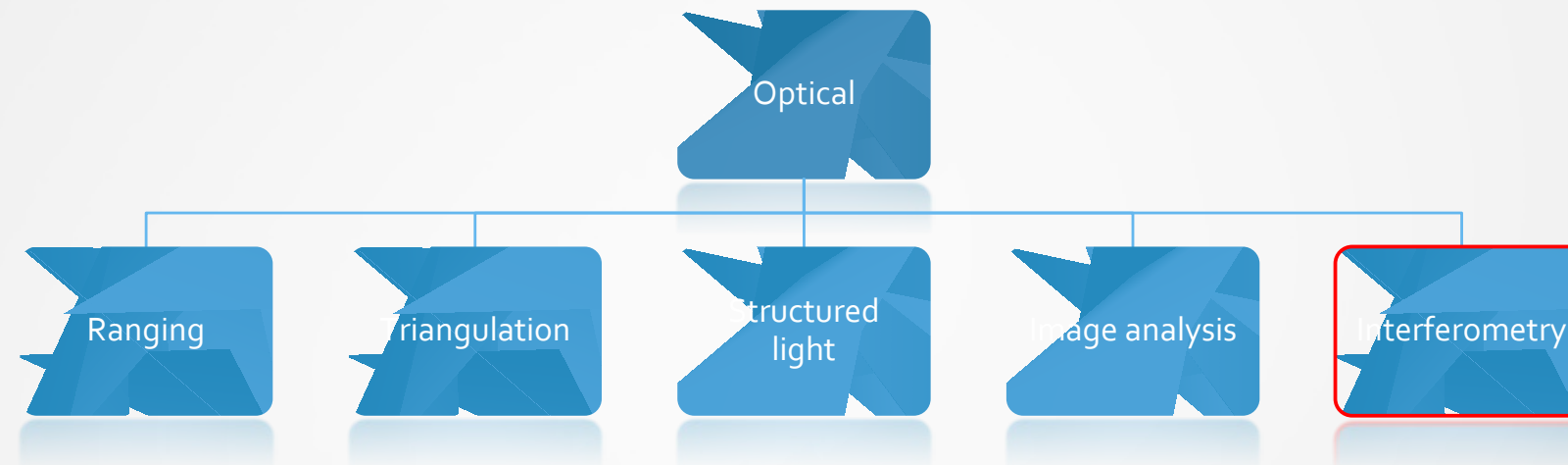

- **Similar to range methods but instead of measuring absolute distances we measure changes in distances.**
- Uses wavelengths and it is more accurate than range methods, since the visible light has a wavelength of the order of hundreds of nanometers.
- A high-energy light source is used to provide both a monochromatic beam of light to probe the object and a reference beam for comparison with the reflected light.
- Based on this comparison the 3D surface of the object is deduced.

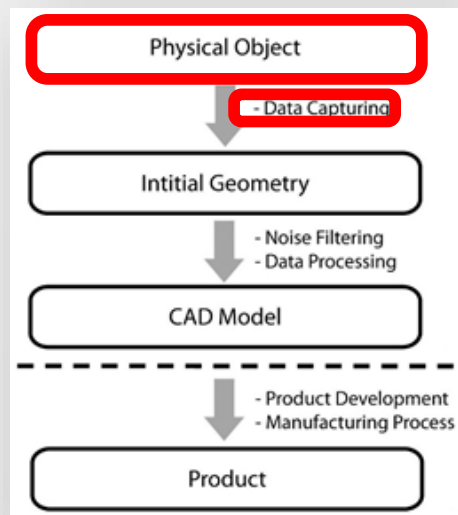

Data Capturing: acoustic

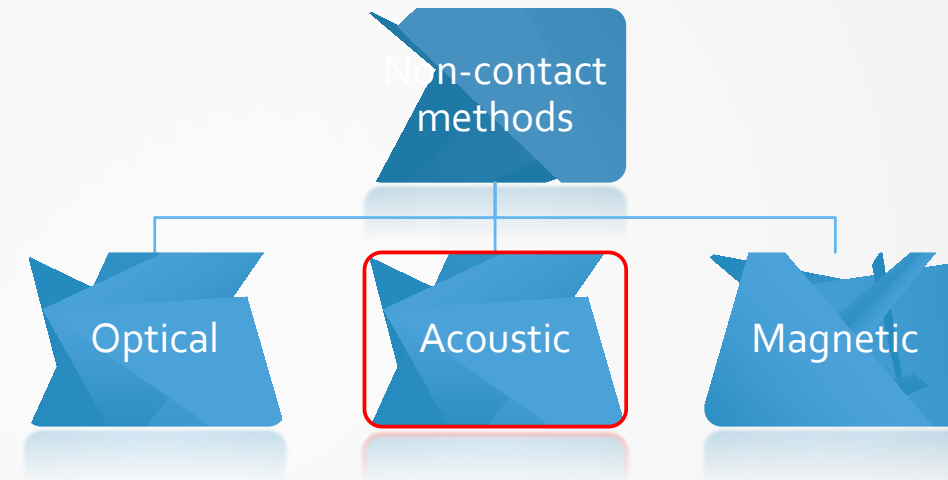

- **Acoustic methods have been used for decades for distance measuring. Sonars are the most indicative example.**
- In principle operate like time-of-flight methods: a sound is emitted from a source it is reflected off the surface of the object. Then the distance between source and surface is determined by knowing the speed of sound.

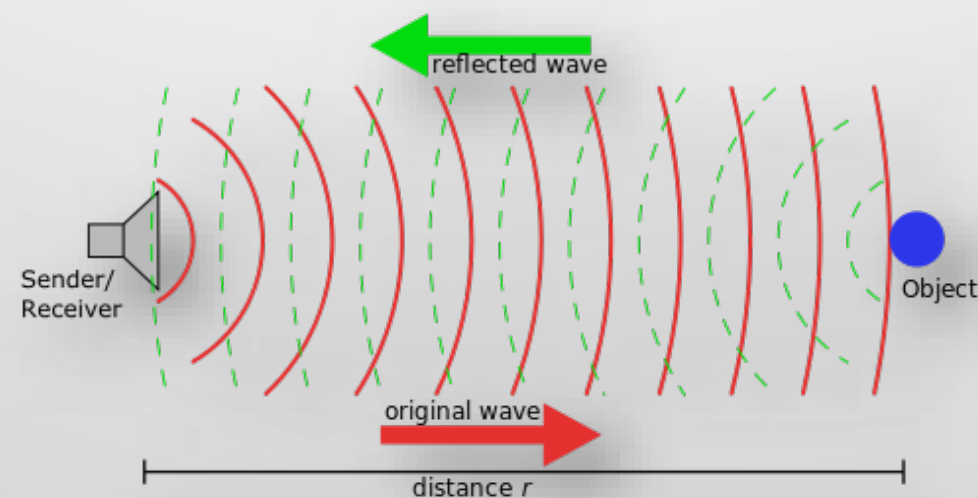

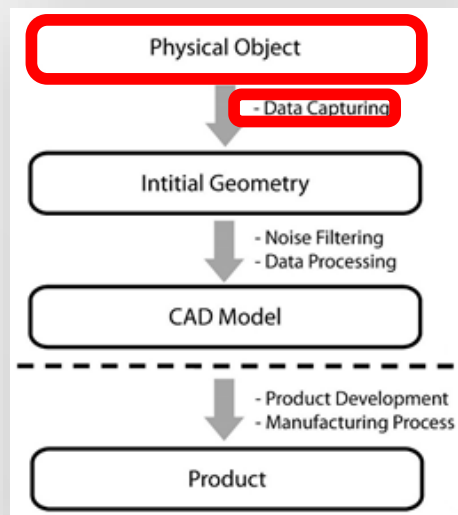

Data Capturing: magnetic

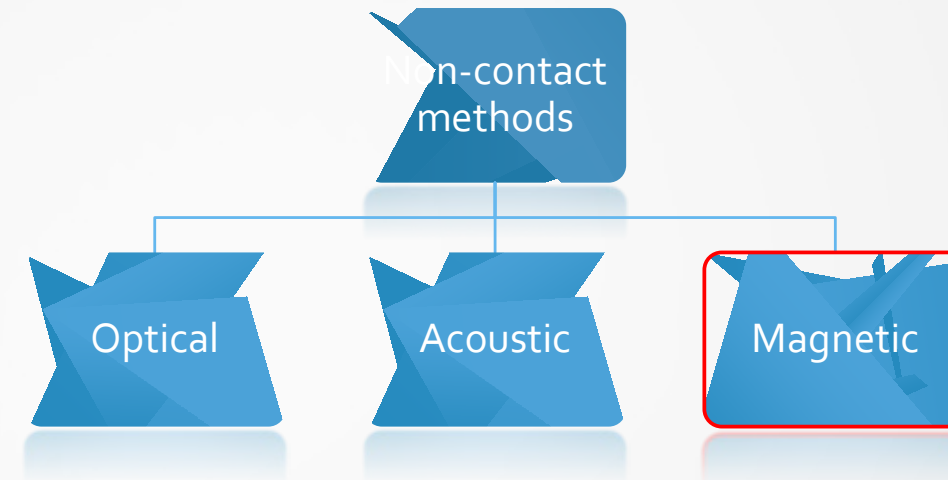

- **Magnetic field measurement involves sensing of the strength of the magnetic field of a source.**
- Magnetic touch probes are able to sense the location and orientation of a stylus within a magnetic field.
- Magnetic resonance imaging (MRI) activates atoms in the internal of the material and then measures the strength of their response.

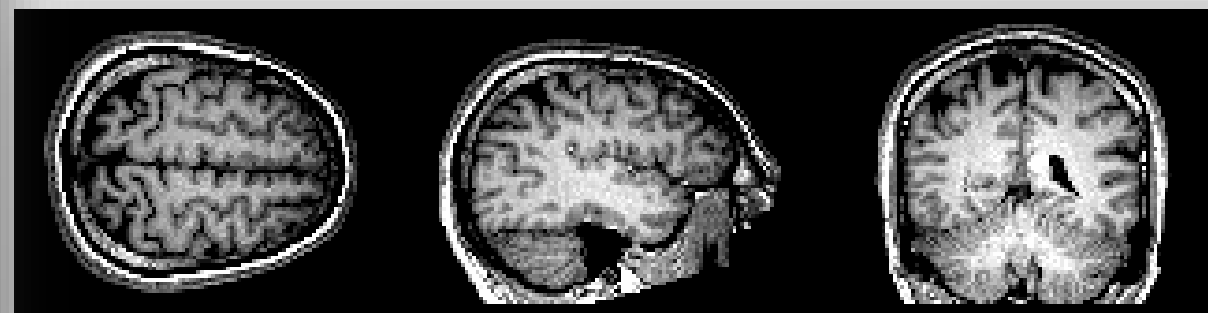

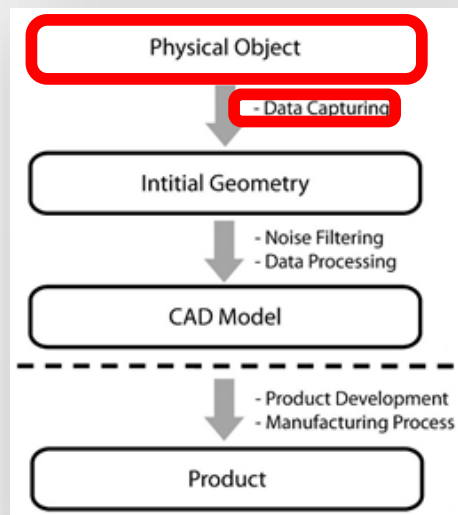

Data Capturing: tactile

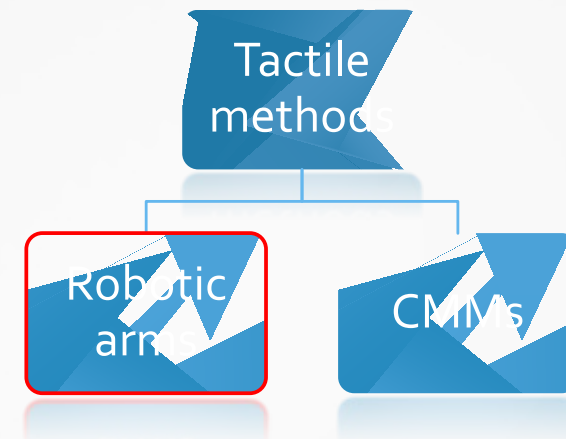

- **Tactile methods touch the surface of the object with a mechanical arm.**
- Sensing devices in the joints of the arm are used to determine the 3D coordinate locations of the arm apex.
- **Robotic arms** are able to provide more degrees of freedom compared to a CMM but require more effort and are slower (i.e., easier to capture concave areas).
- *Modern robotic arms, are combined with a laser range scanner in order to increase data acquisition rate and precision.*

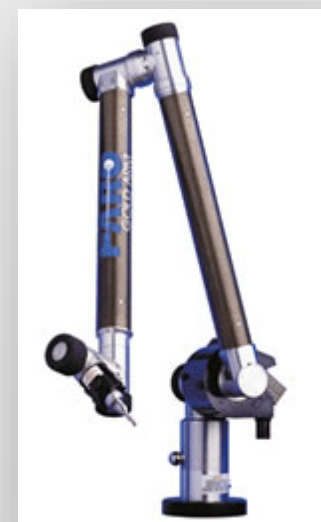
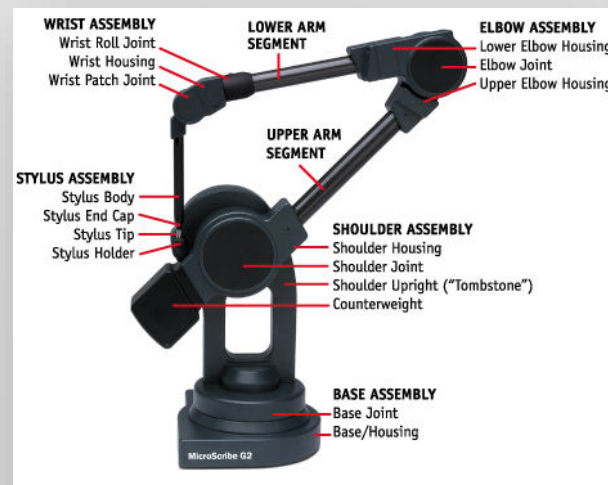

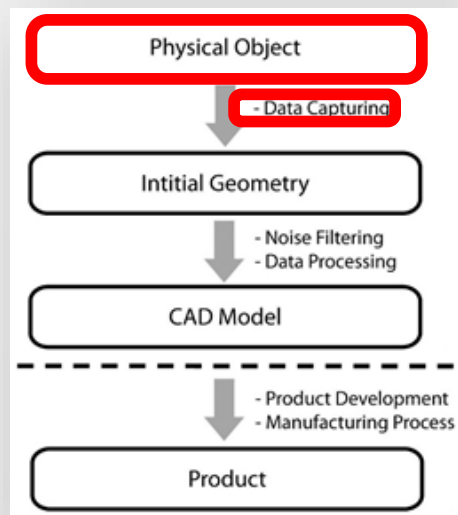

Data Capturing: tactile

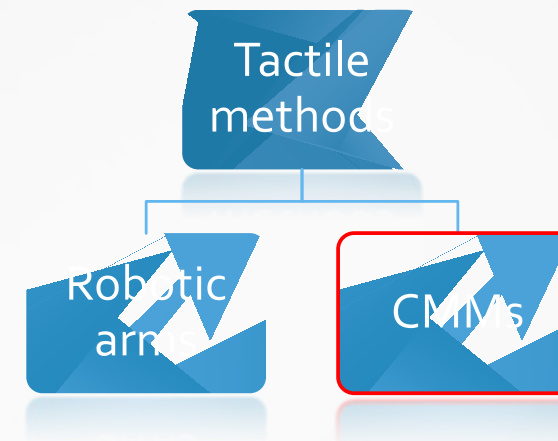

- **Coordinate measuring machines (CMMs) are able to be programmed to follow certain paths along a surface and collect data with high accuracy.**
- Pros of tactile methods: very accurate and free of noise data.
- Cons of tactile methods: The act of scanning the object might modify or damage it. Also, they are relatively slow compared to the other scanning methods. Physically moving the arm that the probe is mounted on can be very slow and the fastest CMMs can only operate on a few hundred hertz. In contrast, an optical system like a laser scanner can operate from 10 to 500 kHz.



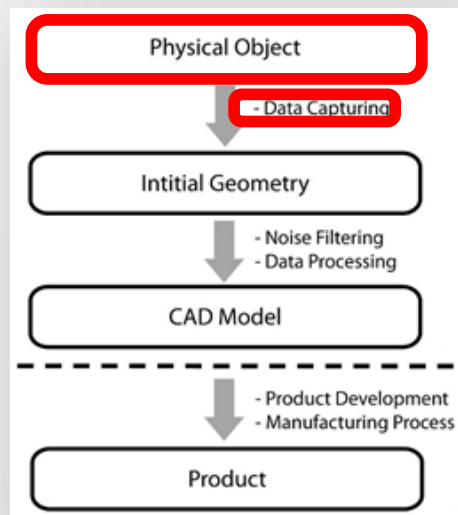

Data Capturing: practical issues

- **Practical problems of data acquisition include:**
 - Calibration
 - Accuracy
 - Accessibility
 - Fixturing
 - Noise and incomplete data
 - Surface finish
 - and others...

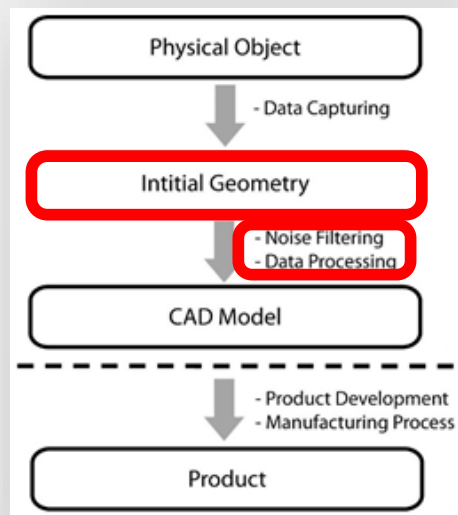

Initial Geometry

- The outcome of the acquisition phase is a set of points in space called as **cloud of points** or **point-cloud**.
- The point-cloud is usually an unorganized set of 3D points (x,y,z) and contains errors like, e.g., noise, outliers, or incomplete data in concave or obscured areas.

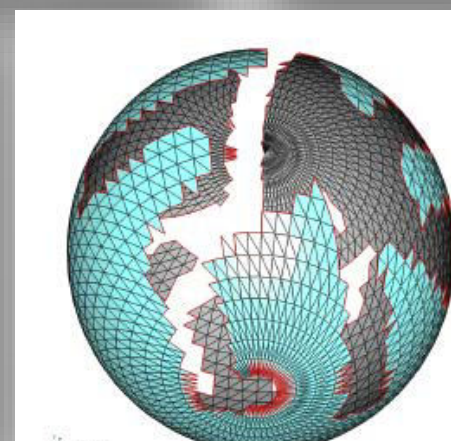
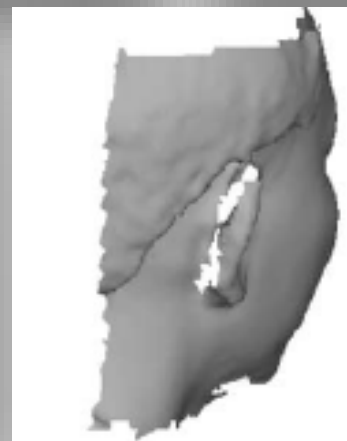
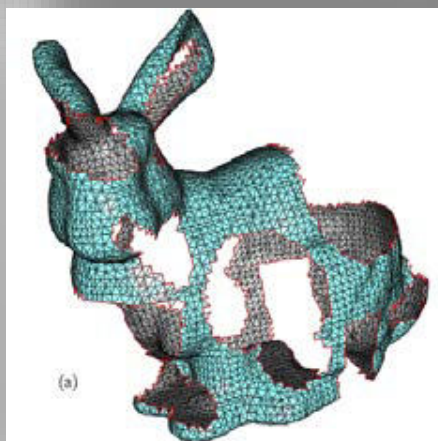
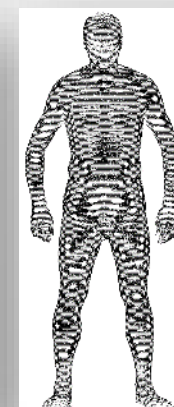
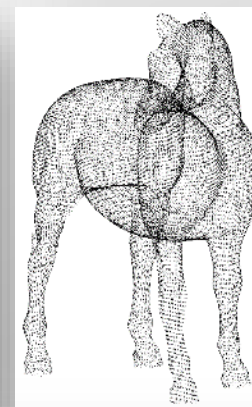
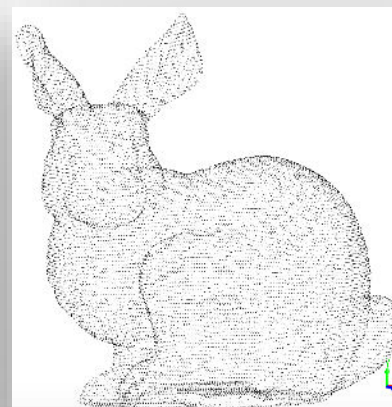
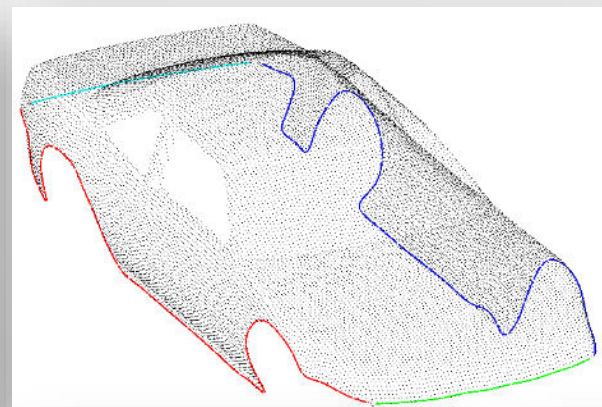
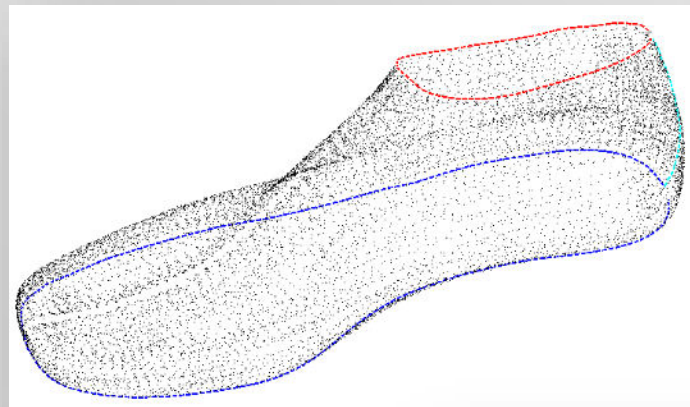

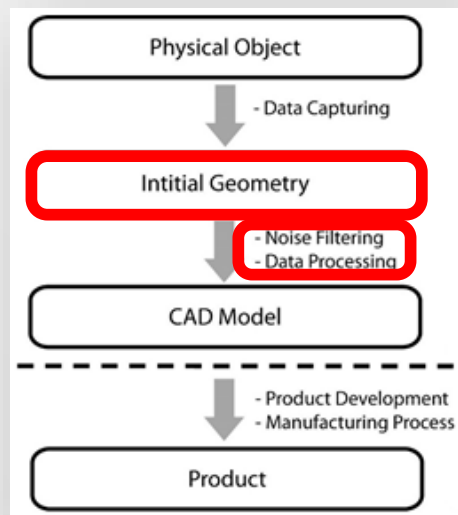

Noise filtering

- Noise filtering methods attempt to identify “discontinuities” in the point cloud and they usually work locally. First, we consider methods for identifying and removing **outliers**.
- An assumption is made on the type of the local surface and those points that don’t comply with this assumption are considered as noise. The related algorithms are classified by the type of the comparisons they apply as³:
 - Slope-based: The difference between two points is calculated and if it is larger than a limit value then the more distant point is considered as noise.
 - Block minimum: The points are considered to lie within a plane according to a tolerance value.
 - Surface-based: Similarly with block-minimum, it is considered that the points lie to a smooth surface within a tolerance.
 - Clustering/Segmentation: The points are grouped in clusters. Then all points within a cluster should belong to the object as long as they are within a maximum distance from their neighbors.

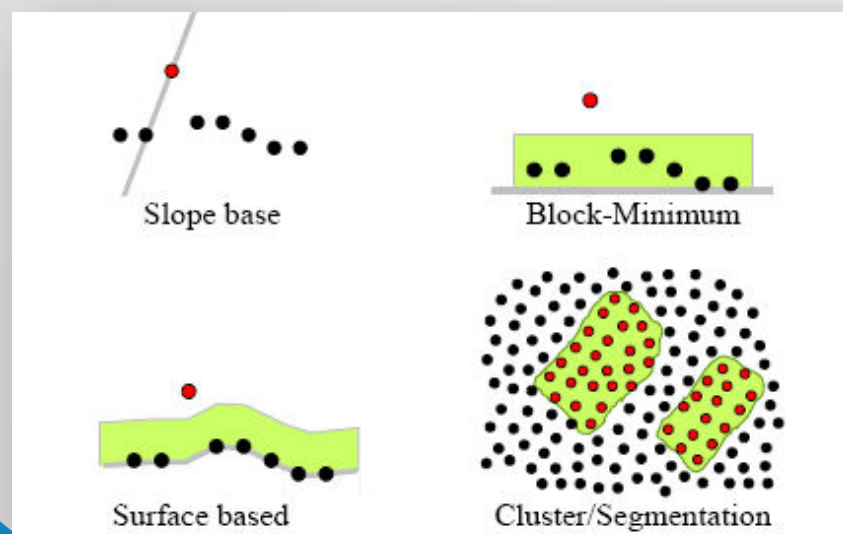

[3] Sithole, G., and G. Vosselman. “Comparison of Filtering Algorithms.” Proceedings of the ISPRS working group III/3 workshop, 2003.

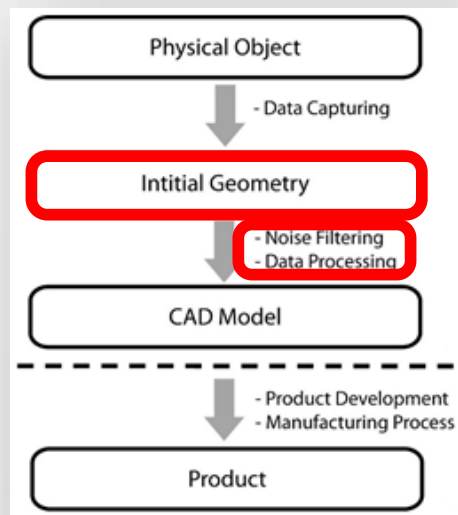

Noise filtering cont.

- Schall, Belyaev and Seidel⁴ developed a method for removing outliers using clustering. For each point of a cluster a likelihood is calculated for this point to belong to the object surface.
- The clusters are determined through density functions whose maxima represent the centers of the clusters.

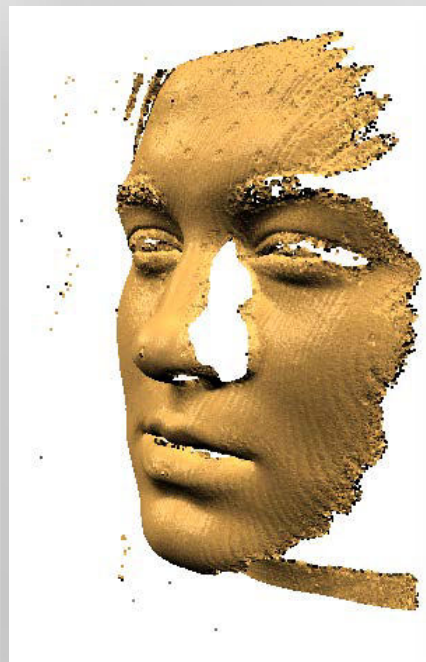

[4] Schall, O., A. Belyaev, and H. P. Seidel. "Robust Filtering of Noisy Scattered Point Data." Eurographics Symposium on Point - Based Graphics, 2005

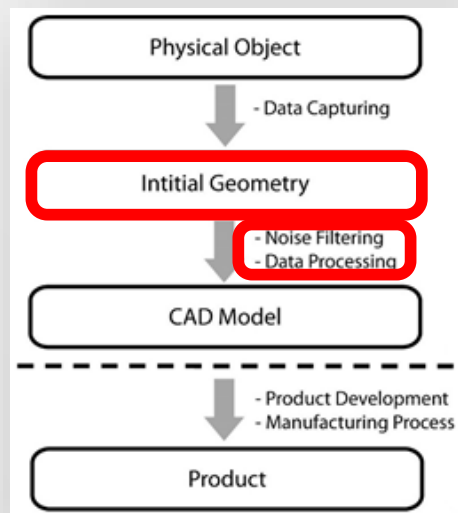

Noise filtering cont.

- Wang and Yuen 2003⁵ developed a method for removing outliers which consists of four steps:
 1. Project the scanned data with noisy points in different directions to obtain binary images.
 2. Apply morphology operators to remove or separate noisy points from the scanned object in each binary image.
 3. Cluster point sets by morphological dilation.
 4. Maintain the points in the set with the maximum number of points and remove points in other sets.

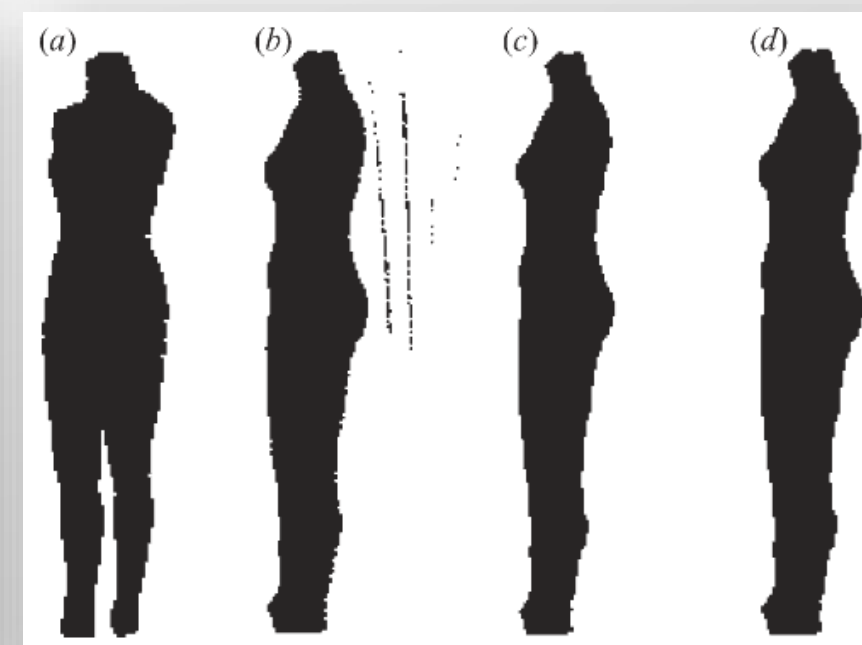
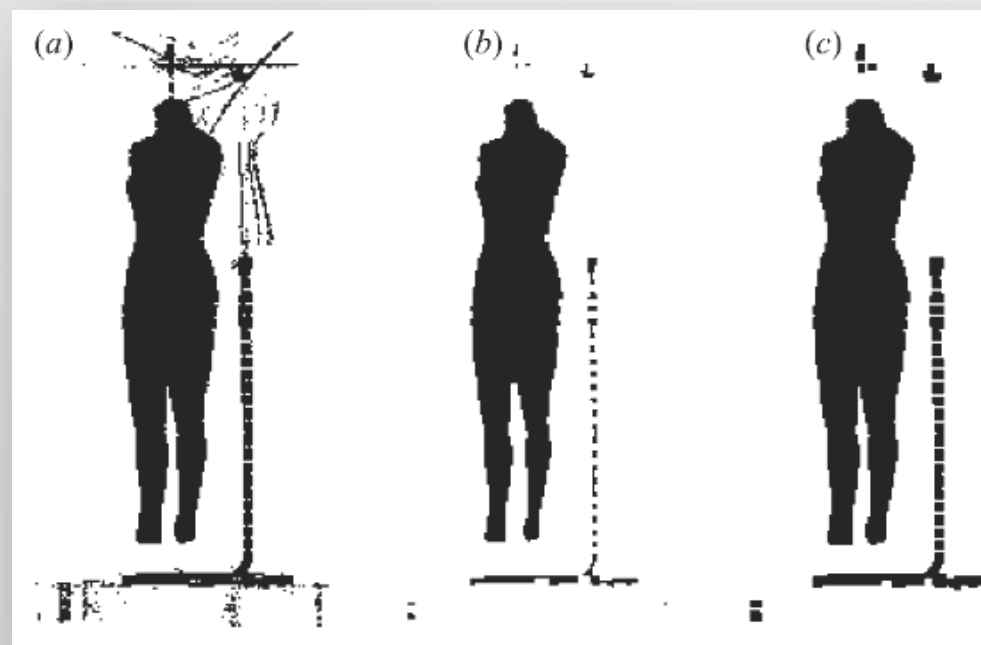

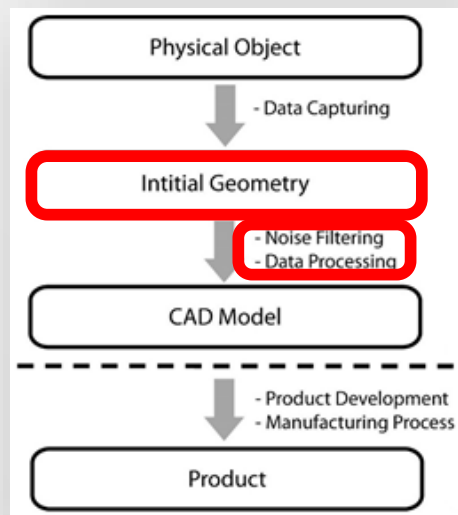

Noise filtering cont.

- We turn our attention to the reduction of small-amplitude noise that results from measuring errors that usually depend on the accuracy of the data acquisition method **a.k.a. Point-cloud Smoothing**
 - Low pass filtering⁶
 - Moving Least-Squares (MLS) filtering^{7,8}
- Noise reduction⁷: Filtering imperfect data and generating a **thin point set**, in the sense that the points do not deviate from the surface being represented.

[6] Linsen L.: Point cloud representation. Tech.Rep. 2001-3, Fakultät für Informatik, Universität Karlsruhe, 2001.

[7] Lee I. K.: Curve reconstruction from unorganized points. Computer Aided Geometric Design, 17(2):161–177, February 2000.

[8] Alexa M., Behr J., Cohen-or D., Fleishman S., Silva C. T.: Point set surfaces. IEEE Visualization 2001 (Oct. 2001),21-28

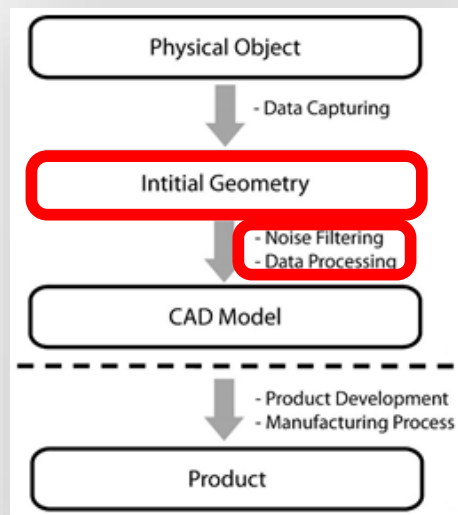

Noise filtering cont.

- Low pass filtering

- A discrete Laplacian smoothing operator is used which moves every point $\mathbf{p}(x,y,z)$ to the centroid formed by its k -neighborhood, i.e.,

$$\mathbf{p}' = \frac{1}{k} \sum_{i=1}^k \mathbf{q}_i$$

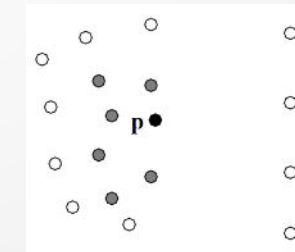

- This kind of smoothing causes shrinkage when applied to all points of the cloud.
- Non shrinkage is obtained if we perform a smoothing step with positive scale factor λ and an un-shrinking step with a negative scale factor μ , such that $\lambda + \mu > 0$.
- In order to take into account the implied geometry the points are summed up using proper weight factors, i.e.,

$$\mathbf{p}' = \frac{1}{k} \sum_{i=1}^k w_i \mathbf{q}_i$$

were weights w_i depend either on the shrinkage factor λ or on the un-shrinkage factor μ .

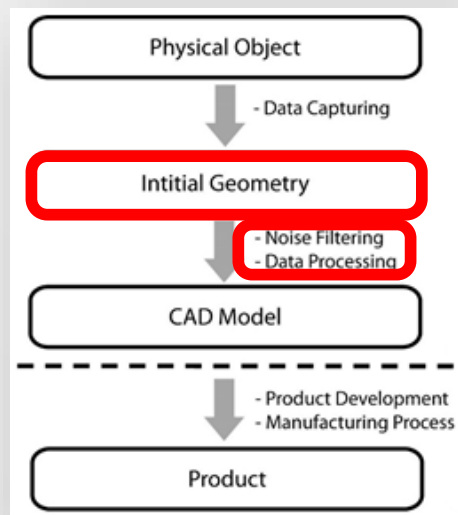

Noise filtering cont.



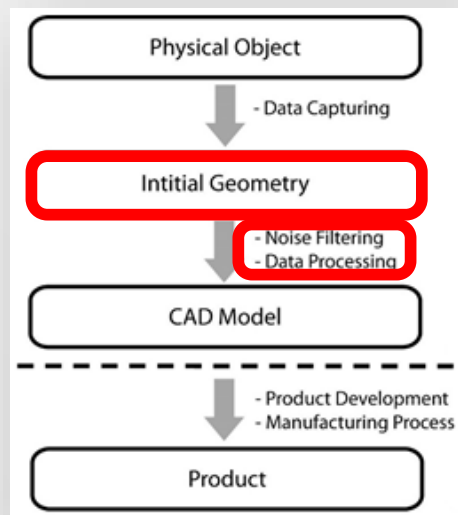

Noise filtering cont.

- Moving Least-Squares filtering
 - Due to noise error the point-cloud is a “thick” point-set approximating the geometry of the object surface.

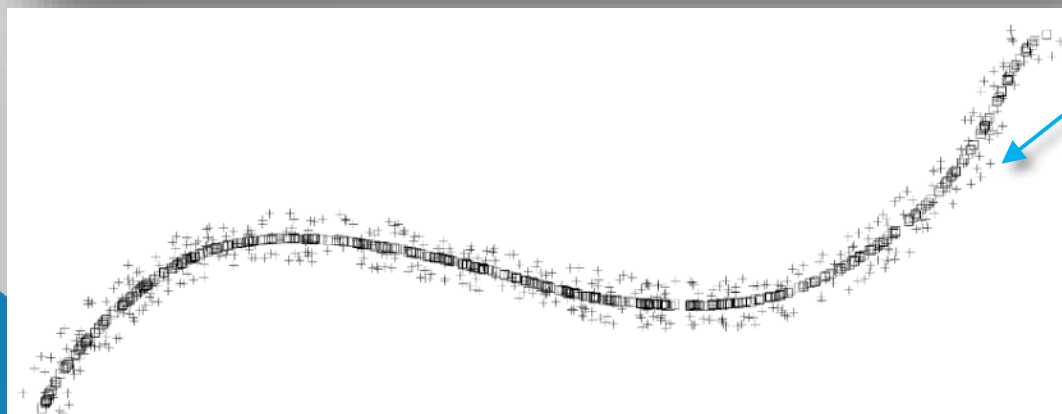
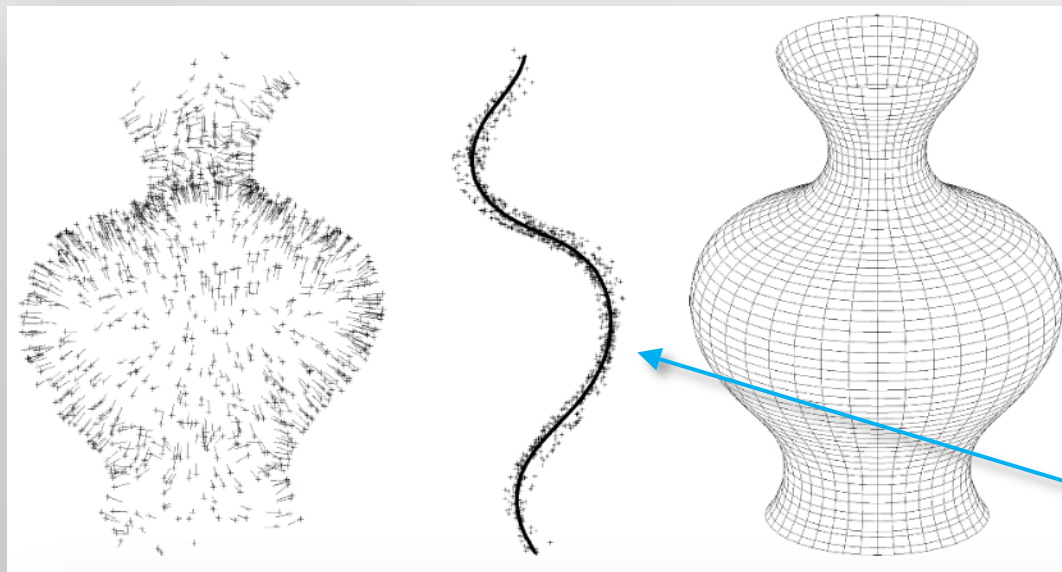

With MLS we try to approximate locally the implied geometry and produce a “thin” point cloud by projecting the noisy points onto the implied object surface.

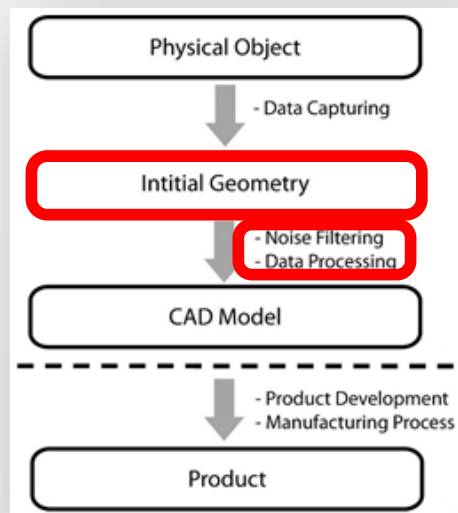

Noise filtering cont.

- Moving Least-Squares filtering example: Move point r on the surface implied locally by the point-cloud.
 1. Construct a reference domain as the plane H that minimizes the Euclidean distance error according to Least-Squares and project r onto q on H .
 2. Using H compute the weights f_i of the local points p_i by their orthogonal projection onto H .
 3. Calculate the local surface g and project q onto that surface.

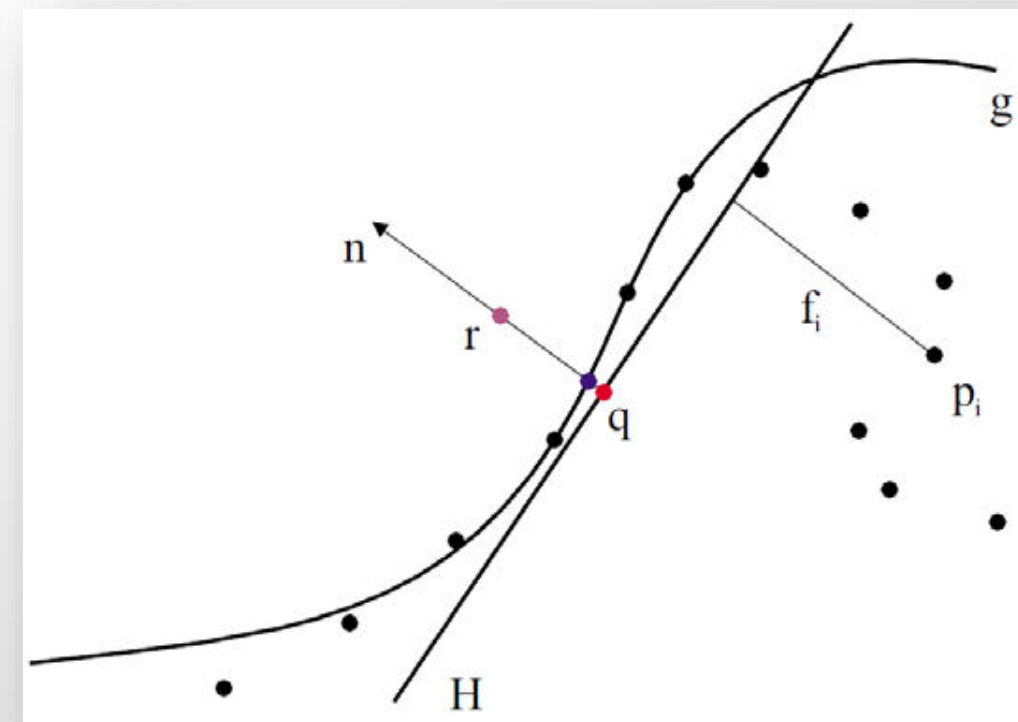

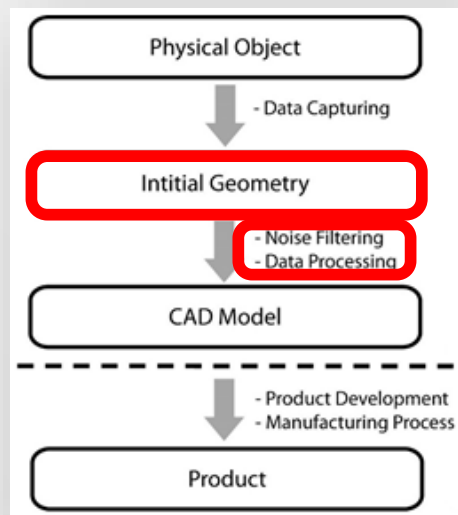

Noise filtering cont.

Different local ranges cause different smoothing results (small range => less smoothing and vice versa).

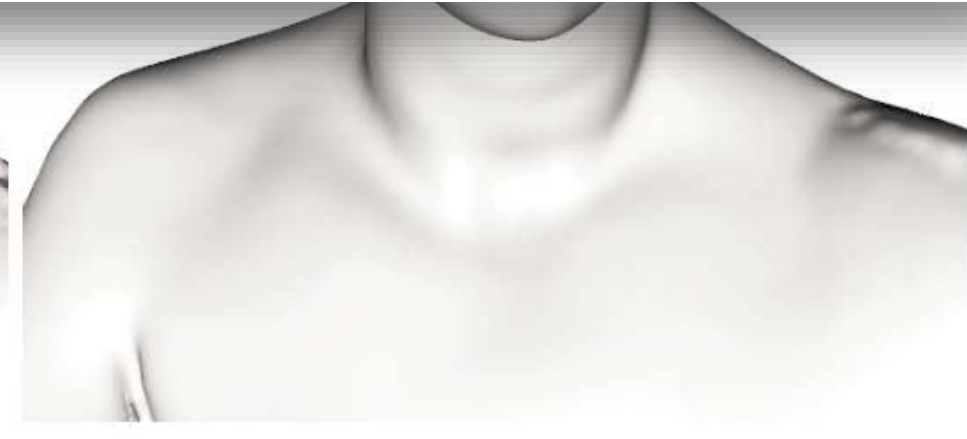
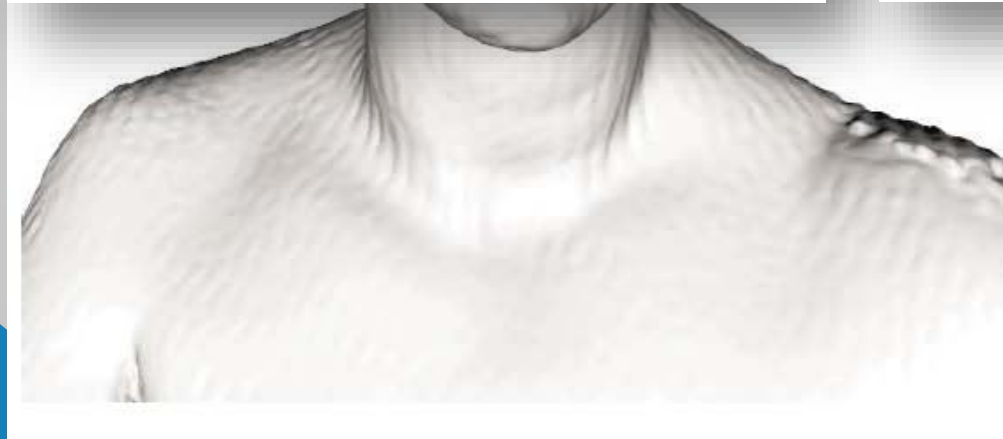
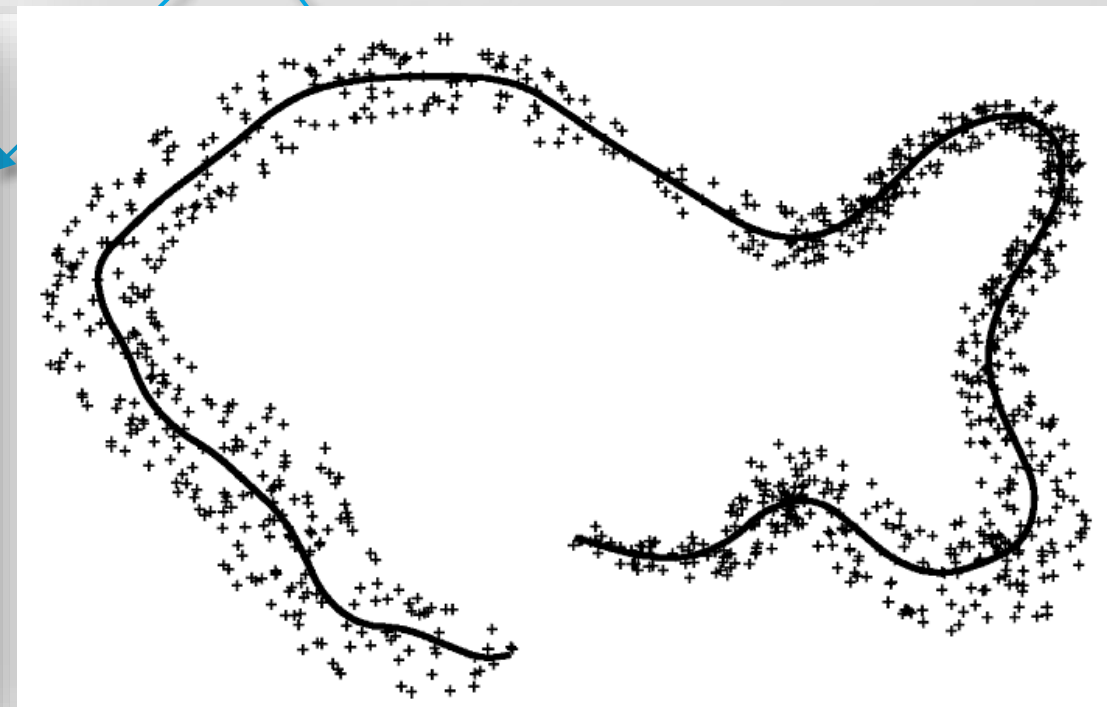
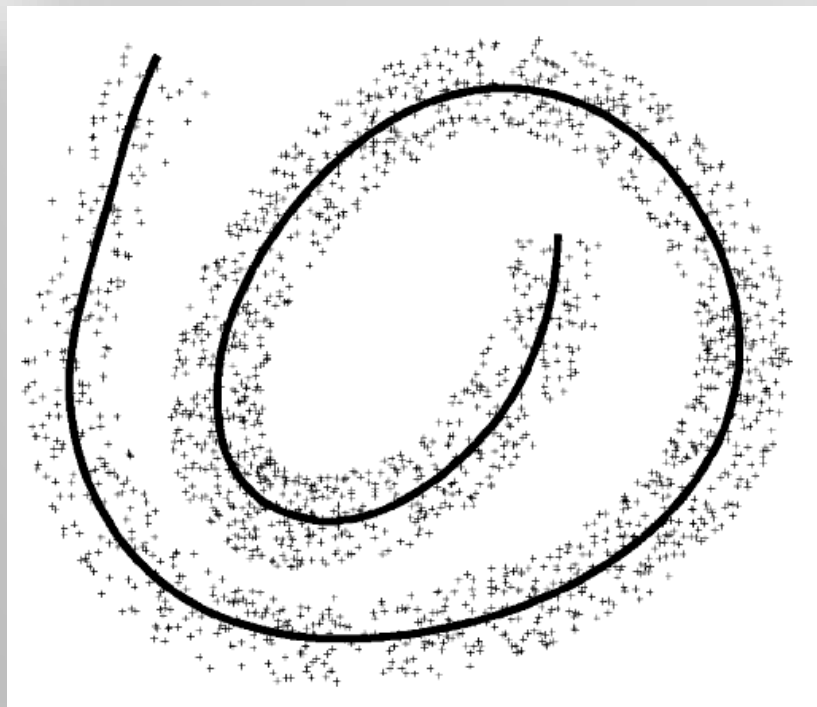

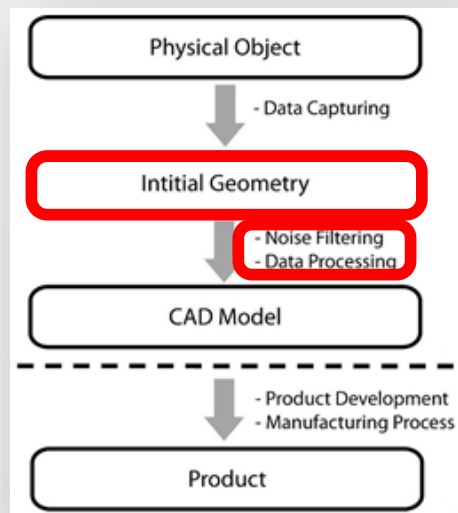

Data processing: down-sampling

- Point-clouds include tenths or hundreds of thousands of points. Are all these points necessary for the reconstruction of the object surface? Clearly no.
- Given a point set, the decimation process repeatedly removes the point that contributes the smallest amount of information to the shape. The criteria that dictate the importance of each point include the distance of points on the surface, the curvature, and so on.
- The majority of down-sampling methods calculate for every point \mathbf{p} an information content $M(\mathbf{p})$ and gradually delete the point with the lowest $M(\mathbf{p})$.
- $M(\mathbf{p})$ is defined in such a way so that it encapsulates information about the object geometry and object color, if the later is captured by the scanning device.
- Linsen⁶ defines

$$M(\mathbf{p}) = a_d M_d(\mathbf{p}) + a_p M_p(\mathbf{p}) + a_c M_c(\mathbf{p}) + a_u M_u(\mathbf{p}) + a_{col} M_{col}(\mathbf{p})$$

where

$M_d(\mathbf{p})$ reflects the distance between sample points in the neighborhood of \mathbf{p}

$M_p(\mathbf{p})$ reflects non-planarity

$M_c(\mathbf{p})$ reflects change of normal and $M_u(\mathbf{p})$ reflects the non-uniformity of this change

$M_{col}(\mathbf{p})$ reflects the RGB color associated to \mathbf{p}

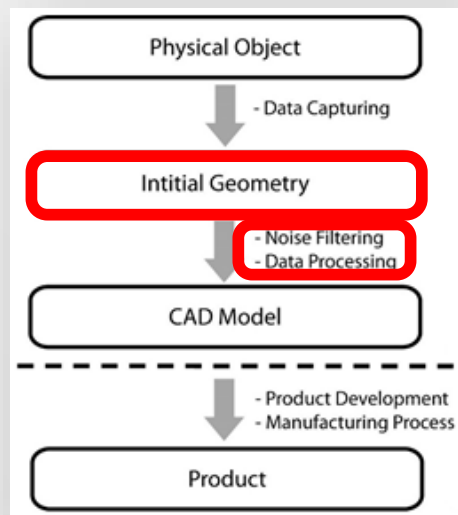

Data processing: down-sampling cont.

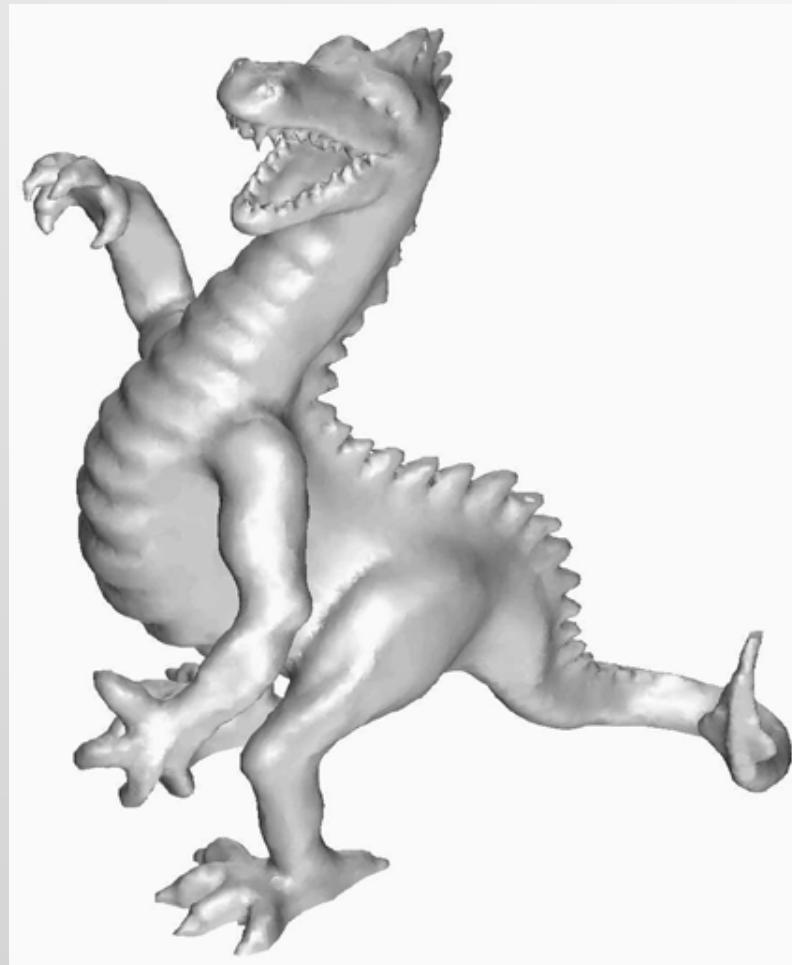

Original point set

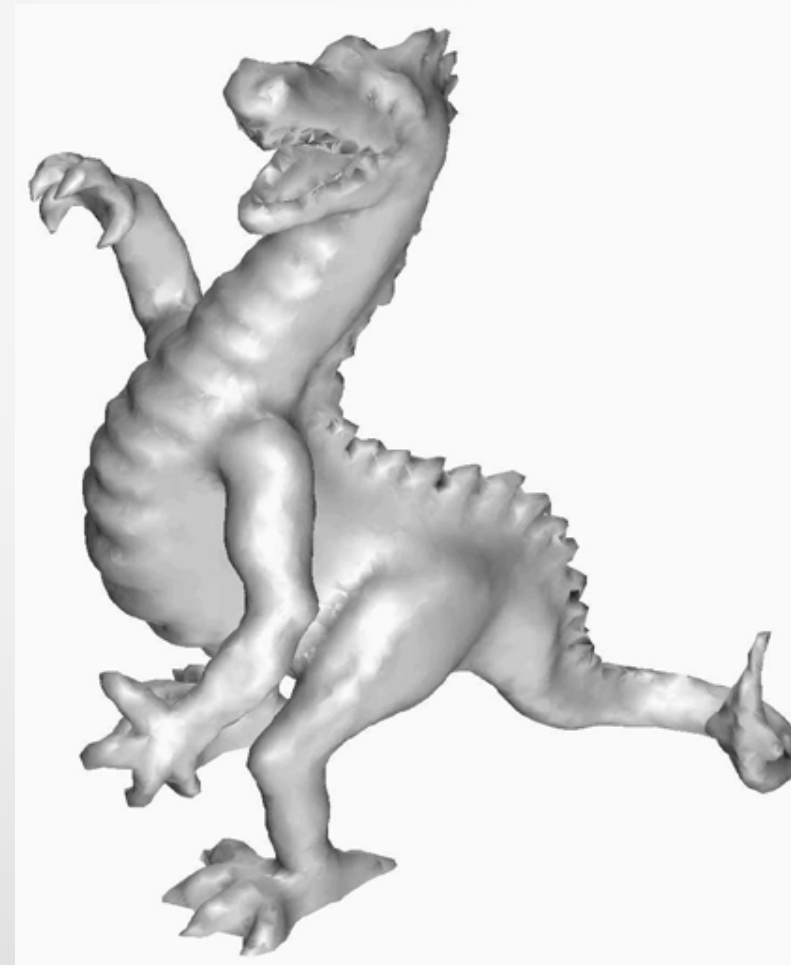

Point set reduction by 42% only by considering distances

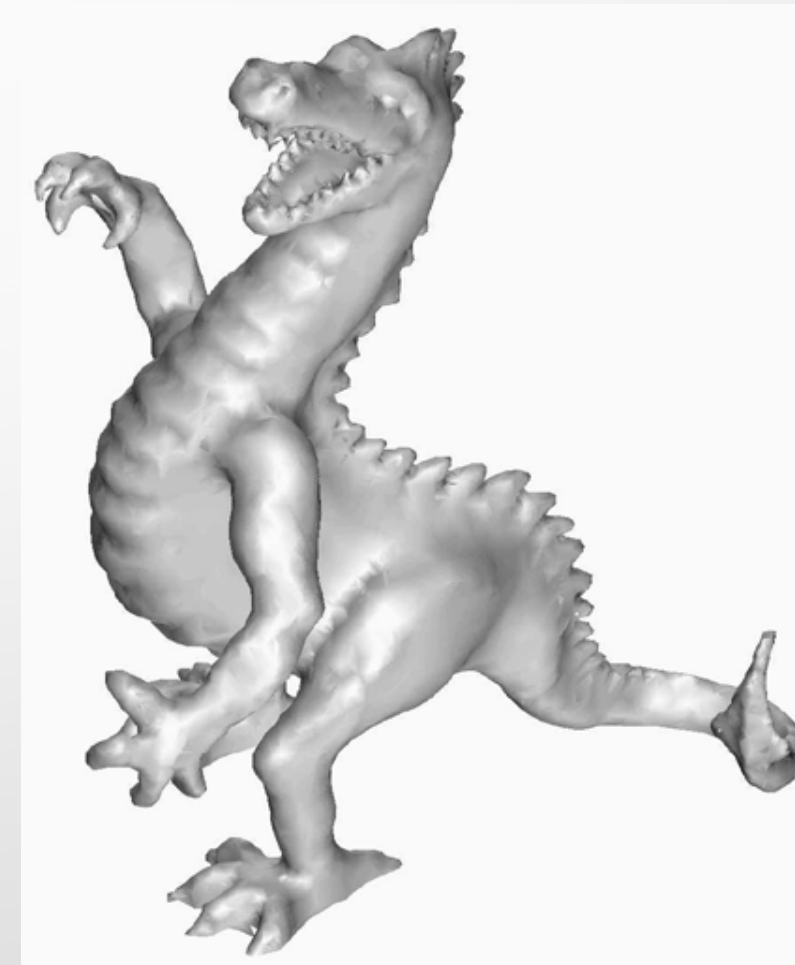

Point set reduction by 42% only by considering distances and geometric features

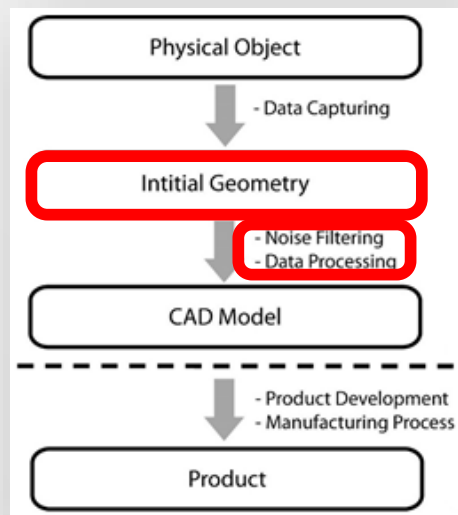

Data processing: down-sampling cont.



Original point set



Point set reduction by
50% without considering
color values



Point set reduction by
50% by considering
color values

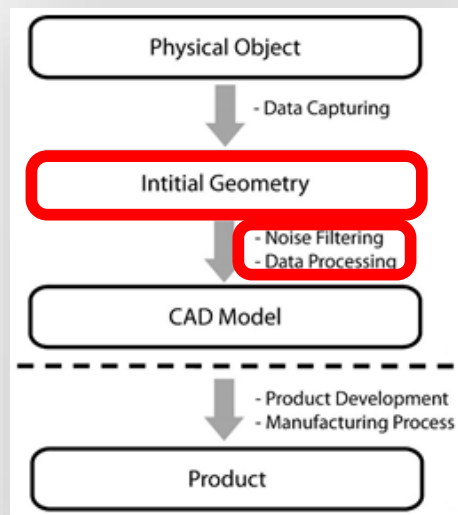

Data processing: down-sampling cont.

- Alexa et al.⁸ propose the following down-sampling method by taking into account the local surfaces defined through the MLS phase:
 - The contribution of a projected point \mathbf{p}_i to the surface S_p can be estimated by comparing S_p with $S_{p-\{\mathbf{p}_i\}}$.
 - The contribution of \mathbf{p}_i is estimated by its distance from its projection onto the surface $S_{p-\{\mathbf{p}_i\}}$. Thus, they estimate the difference of S_p and $S_{p-\{\mathbf{p}_i\}}$ by projecting \mathbf{p}_i onto $S_{p-\{\mathbf{p}_i\}}$ (projecting \mathbf{p}_i under the assumption it is not part of the point-cloud).
 - The contribution values of all points are inserted into a priority queue. At each step of the decimation process, the point with the smallest error is removed from the point set and from the priority queue.
 - After the removal of a point, the priority queue is recalculated
 - This process is repeated until the desired number of points is reached or the contributions of all points exceed some prespecified bound.

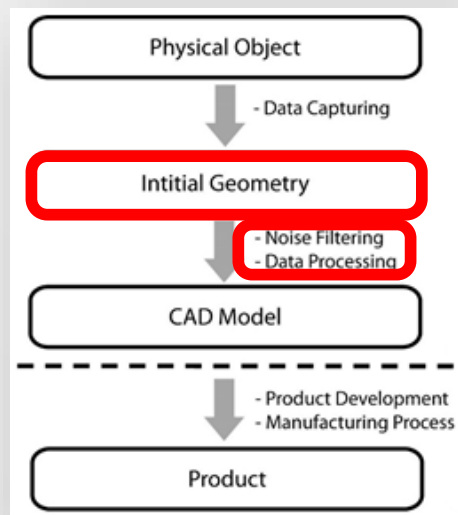

Data processing: down-sampling cont.

Intermediate step of the
reduction procedure

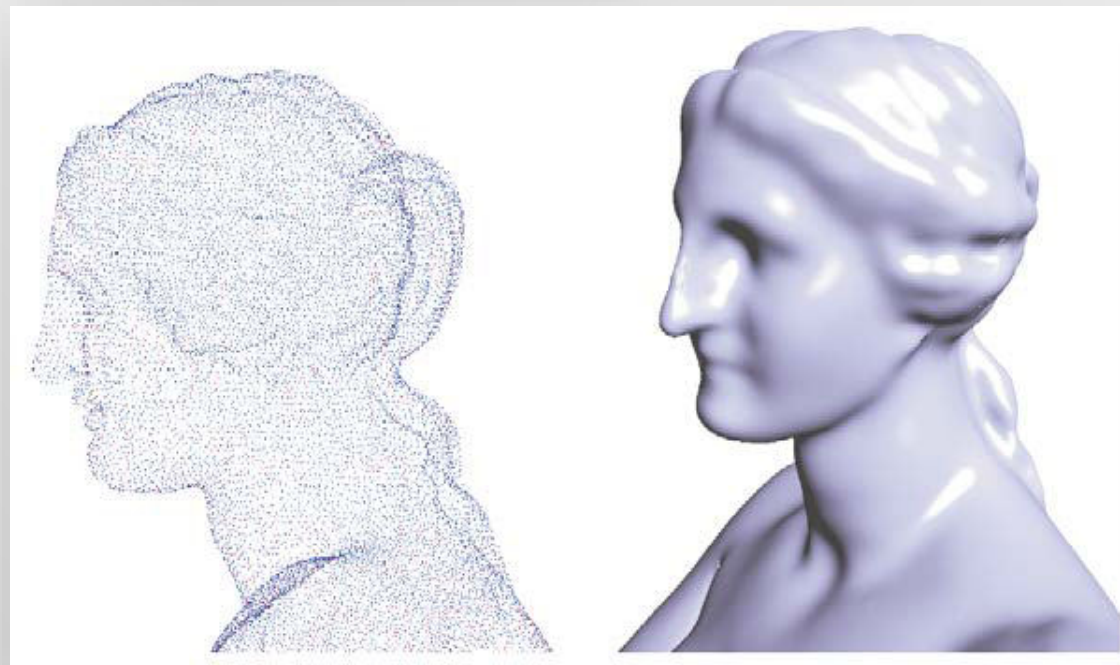

Original point set and MLS
surface with 37K points.

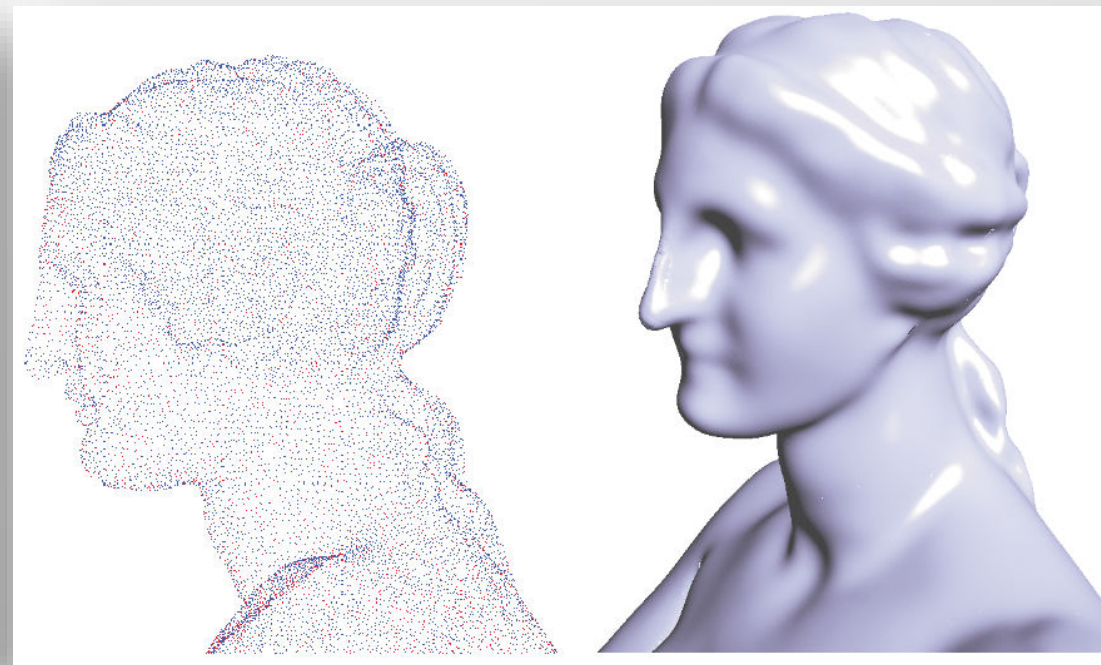

The final point-cloud with 20K
points

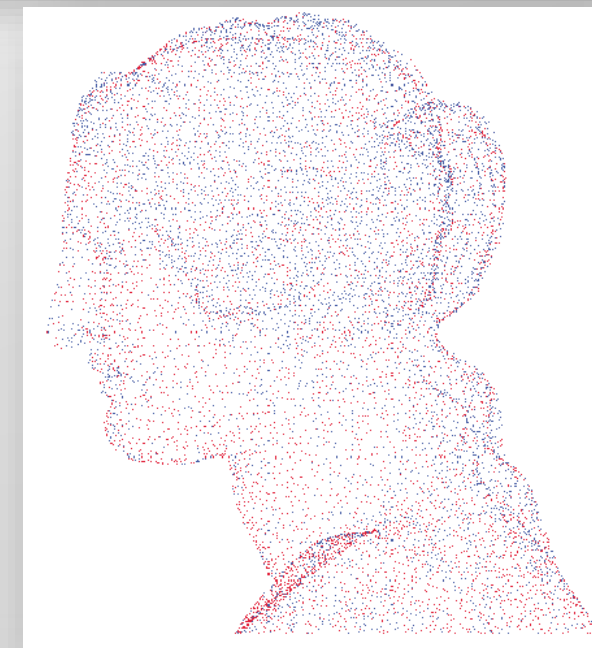

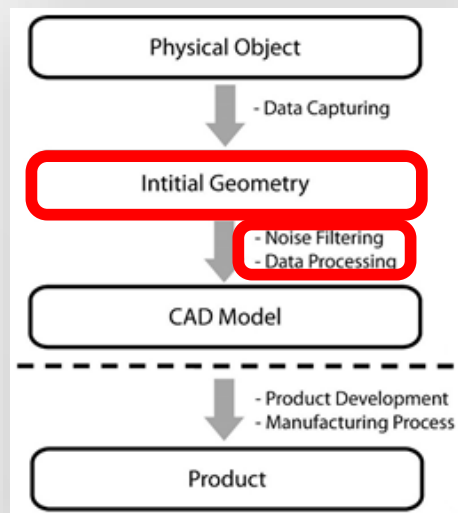

Data processing: up-sampling

- In some cases, the density of the point set might not be sufficient for the intended usage.
- To alleviate this problem, we try to decrease the spacing among points. Additional points should be placed where the spacing among points is larger than a specified bound.
- Alexa et al.⁸ propose the following up-sampling method:
 - In each step, one of the existing points is selected randomly. A local linear approximation is built and nearby points are projected onto this plane. The Voronoi diagram of these points is computed. Each Voronoi vertex is the center of a circle that touches three or more of the points without including any point. The circle with largest radius is chosen and its center is projected to the MLS surface.
 - The process is repeated iteratively until the radius of the largest circle is less than a user specified threshold.
 - At the end of the process, the density of points is locally near-uniform on the surface.

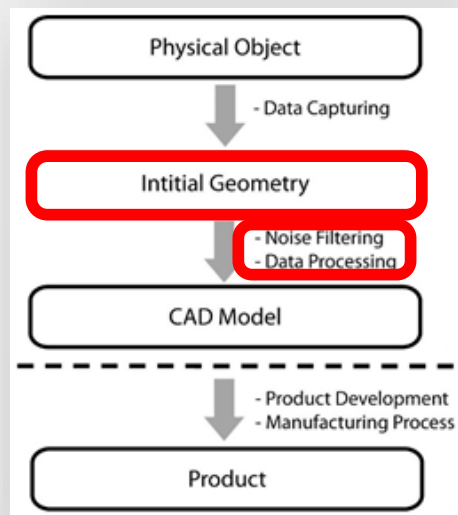

Data processing: up-sampling cont.

- The up-sampling process:
 - Points are added at vertices of the Voronoi diagram. In each step, the vertex with the largest empty circle is chosen.
 - The process is repeated until the radius of the largest circle is smaller than a specified bound.
 - The wavy torus originally consisting of 800 points has been up-sampled to 20K points.

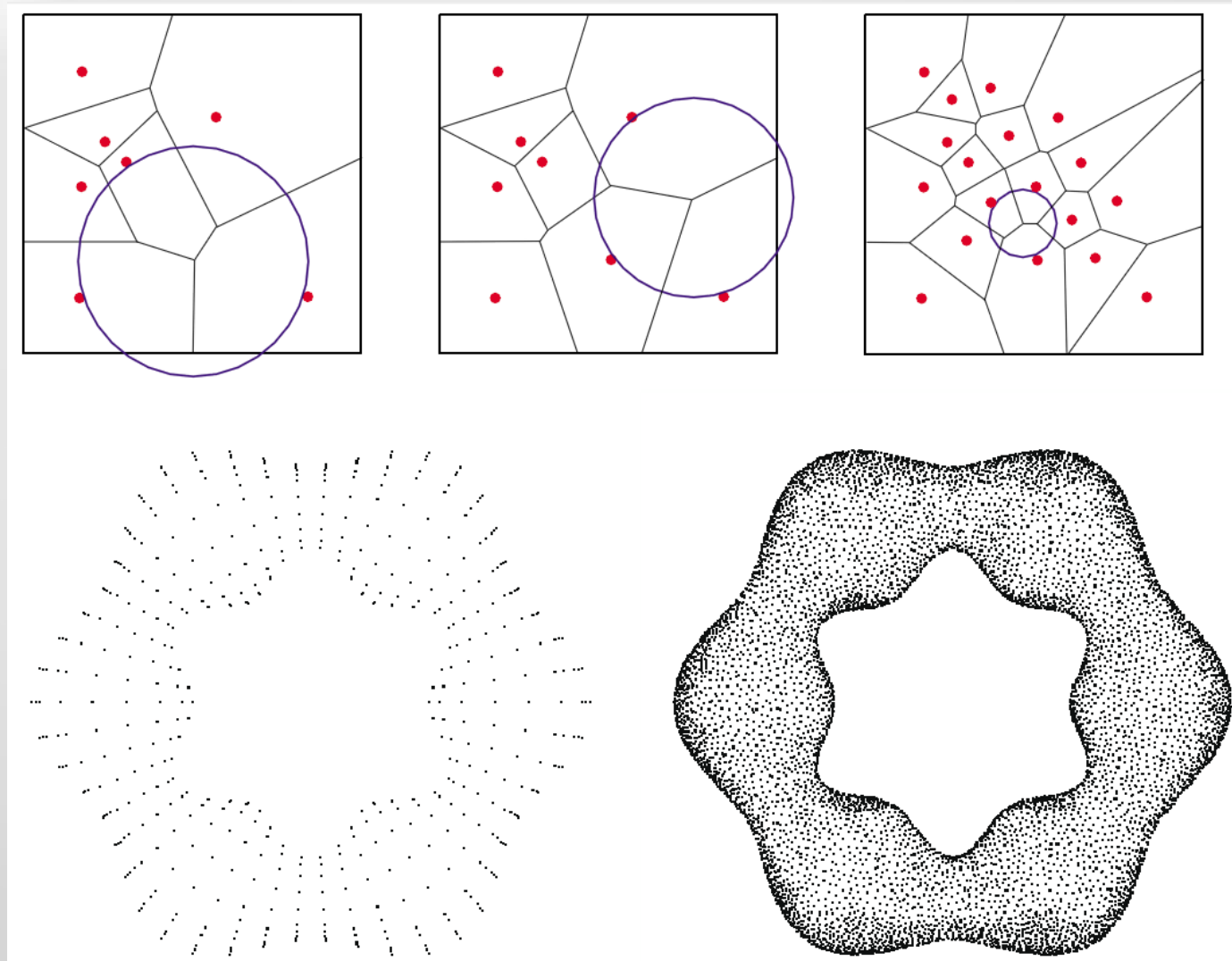

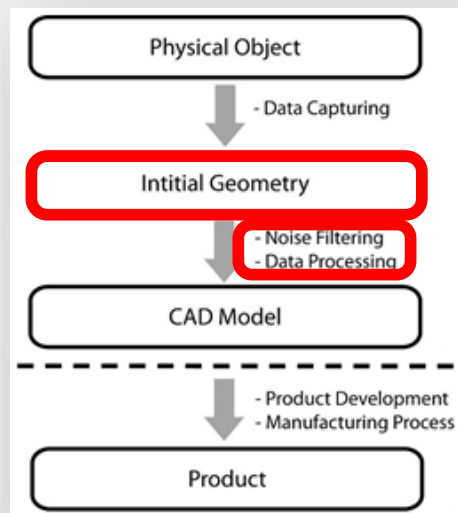

Data processing: hole filling

- Due to difficulties in digitizing concave or obscured areas in the object surface incomplete data or gaps will appear at the point-cloud.
- The process of completing these missing data with points that approximate the geometry of the implied object surface is called as “**hole filling**”.
- Usually hole filling takes place after the production of a triangle mesh of the point-cloud.

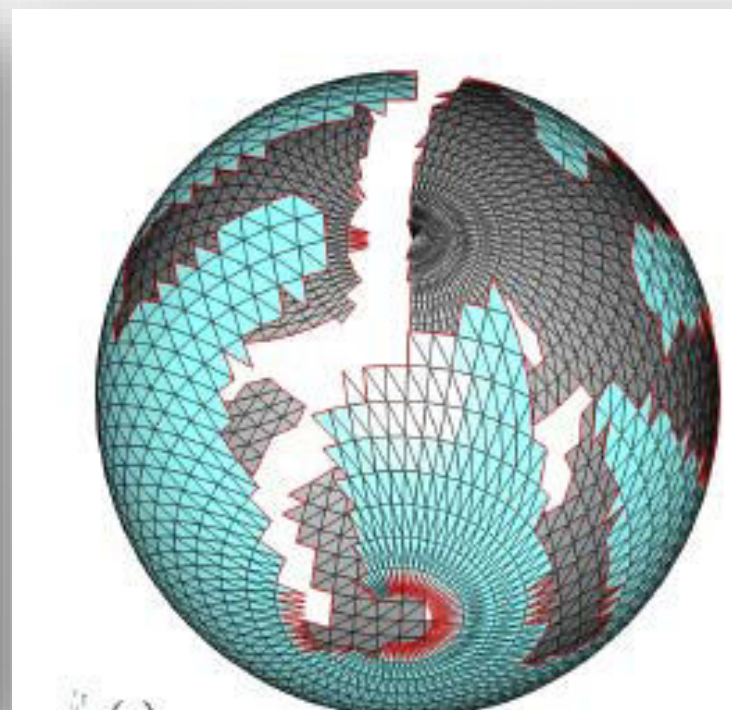
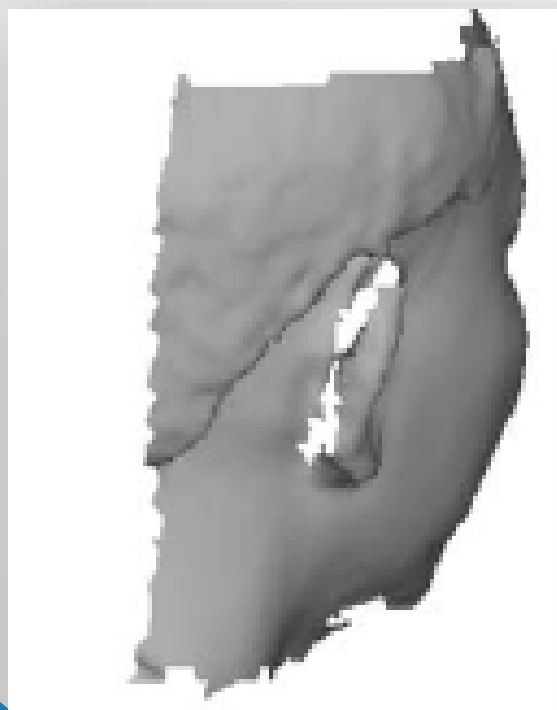

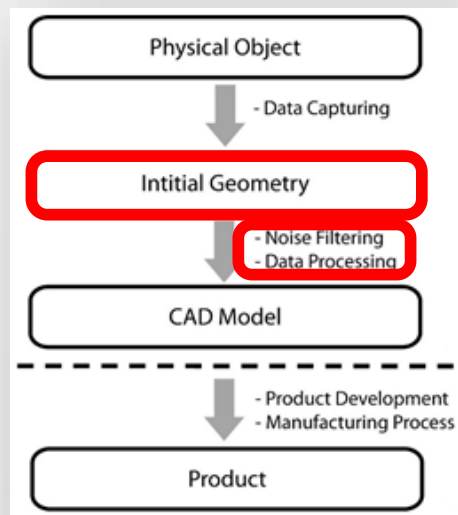

Data processing: hole filling cont.

- General Procedure in hole filling:
 - Identify the boundaries of the hole to be filled.
 - Fill the gap by producing a local triangle mesh that connects points along the identified boundary.
- Jun⁹ describes a hole-filling algorithm for a triangulated point-cloud.
 1. The hole boundaries are determined by the triangles whose one edge belongs to only one triangle.
 2. The hole boundary is projected onto a plane P which is defined by summing up the normal vectors of the boundary triangles.
 - a. If no self-intersections occur at the projected boundary the gap is filled with a direct application of Delaunay triangulation method.
 - b. Otherwise, the boundary is subdivided into simpler parts according to the points of self-intersection and Step 2 is repeated.

Data processing: hole filling cont.

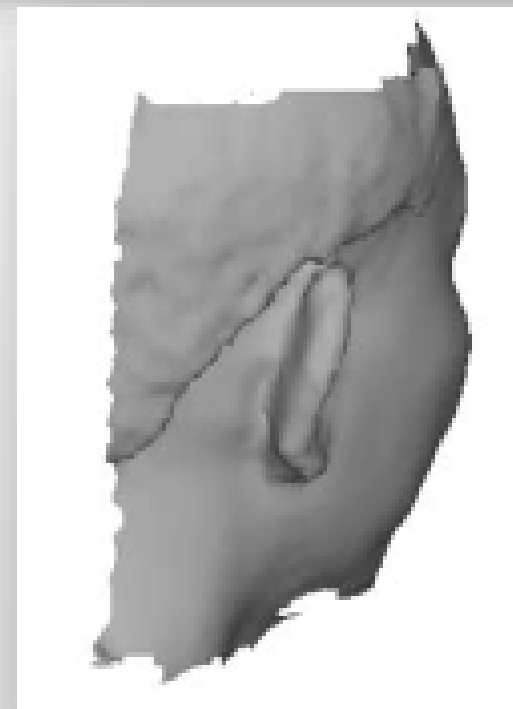
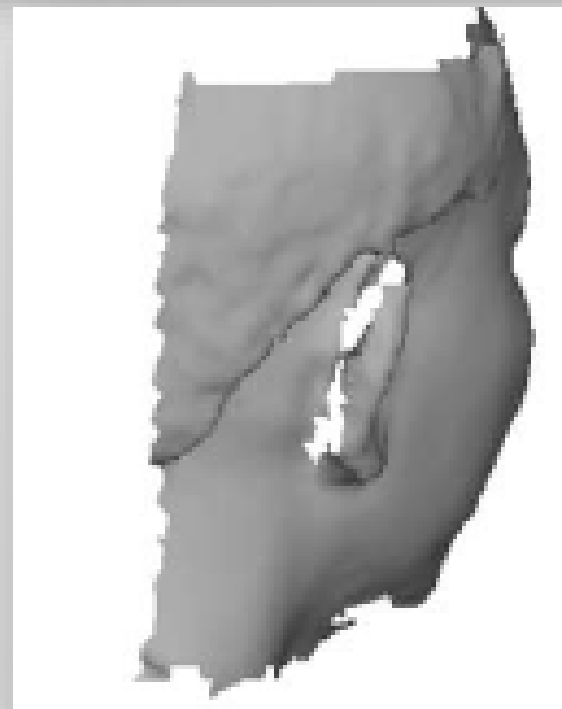
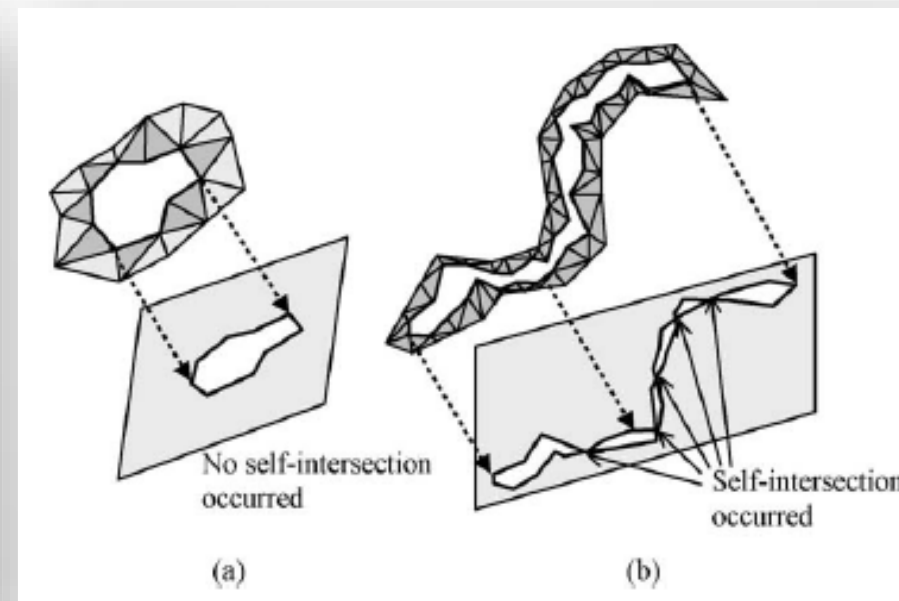
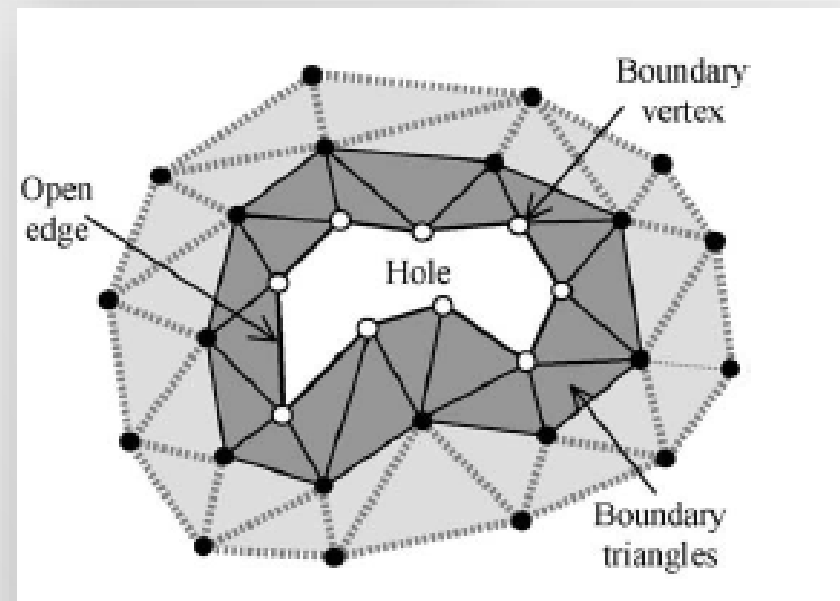
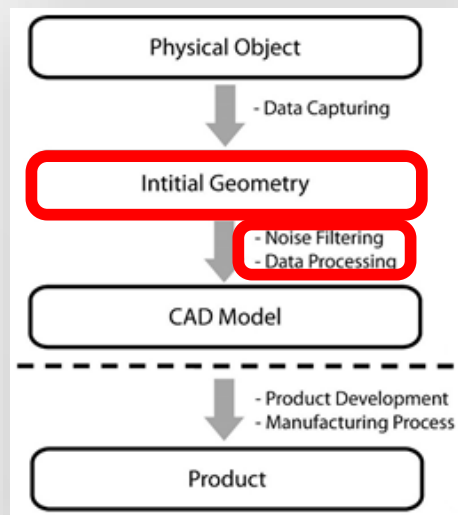

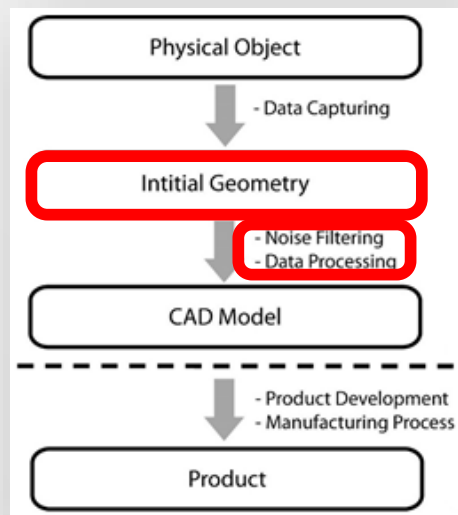

Data processing: hole filling cont.

- Liepa¹⁰ proposes a similar procedure as follows:
 - a. The hole boundaries are determined by the triangles whose one edge belongs to only one triangle.
 - b. A 3D triangle mesh algorithm is directly applied to the 3D boundary of the hole.
 - c. Certain smoothing functionals are incorporated to adopt the new local triangle mesh with the global one.

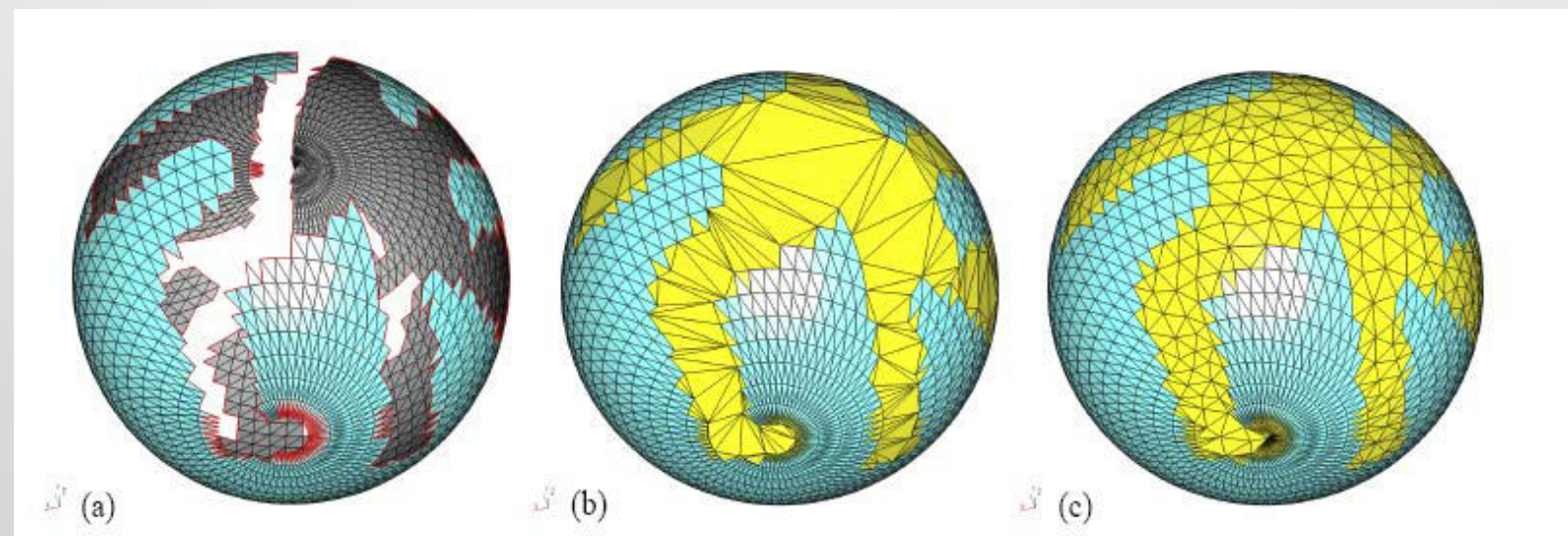

A note on Delaunay triangulation

- A *Delaunay triangulation* for a set P of points in a plane is a triangulation $DT(P)$ such that no point in P is inside the circumcircle of any triangle in $DT(P)$.
- Delaunay triangulations maximize the minimum angle of all the angles of the triangles in the triangulation; they tend to avoid skinny triangles.
- The triangulation is named after Boris Delaunay for his work on this topic from 1934.

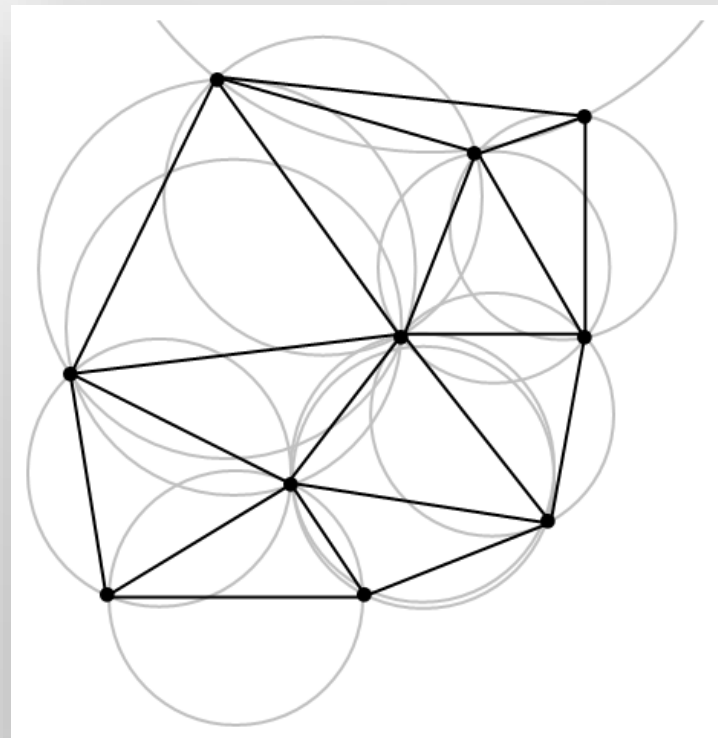

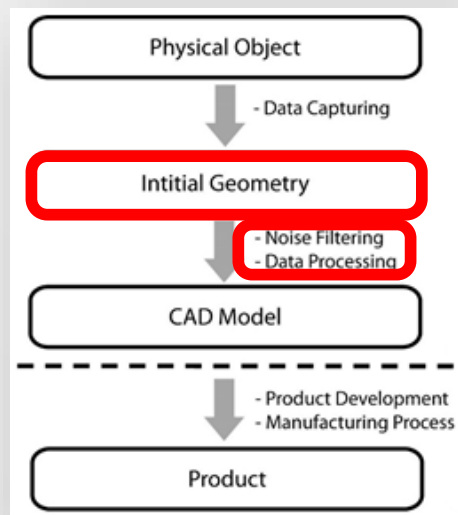

Data processing: segmentation

- Segmentation is the process which provides the necessary organization of the data points by partitioning them into connected regions or parts that can be approximated by standard CAD surfaces or parts (e.g. planes, cylinders, parametric surfaces, etc.)¹¹.
- Can be applied to (a) triangulated point-cloud or (b) to original point-cloud after noise removal
- Most common choice is to apply segmentation after the point-cloud triangulation.

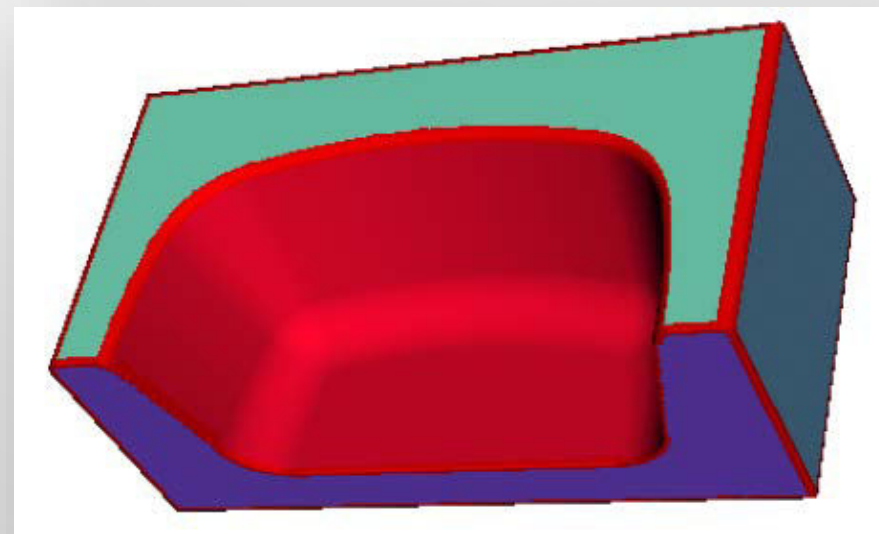

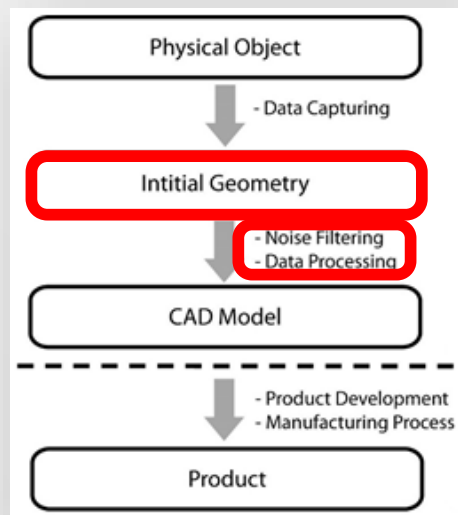

Data processing: segmentation cont.

- A recent study¹¹ reported that there are at least 12 different approaches for segmenting a 3D mesh surface:

- | | | |
|--------------------|----------------------|--------------------------|
| 1. Region Growing | 5. Skeleton-based | 9. Critical-Points Based |
| 2. Watershed-based | 6. Clustering | 10. Multiscale Shape |
| 3. Reeb Graphs | 7. Spectral Analysis | Descriptors |
| 4. Model-based | 8. Explicit Boundary | 11. Markov Random |
| | Extraction | Fields |
| | | 12. Direct Segmentation |

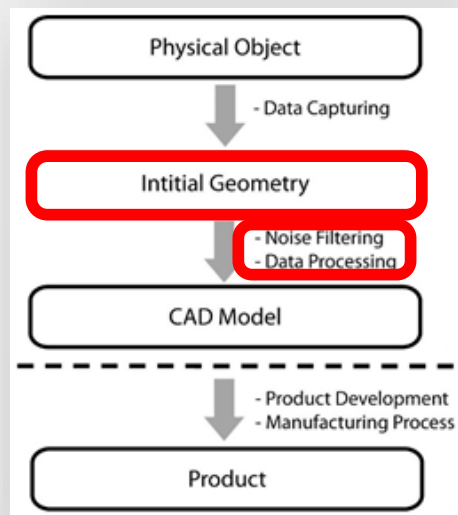

Data processing: segmentation cont.

The segmentation methods can be grouped into two main categories:

- **Surface-based:** The 3D mesh is segmented into regions which represent distinct surfaces of the CAD model and can be approximated by various primitives like planes, cylinders, spheres, polynomials, etc.
- **Part-based:** The 3D mesh is segmented into meaningful volumetric parts which can be approximated by volumetric primitives (e.g. super-ellipsoids).
- **Quality of segmentation**
 - Surface-based algorithms: (i) The boundaries of the segmented regions should be smooth, (ii) The extracted regions should be able to be approximated by smooth surfaces, (iii) The boundaries where the regions meet should allow certain types of continuity (like C^1 or C^2) to hold for the approximating surfaces.
 - Part-based algorithms: Application of the Minima Rule: *An object is segmented by human perception at areas of concavity.*

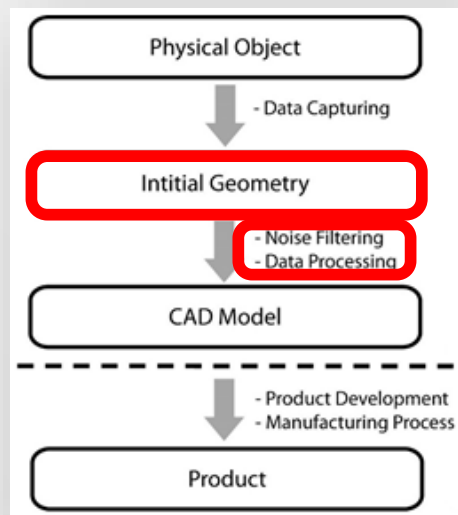

Data processing: segmentation cont.

- **Region growing**¹²: Complex smooth surfaces can be decomposed into a disjoint union of surface primitives that can be approximated by low order polynomials.
- The segmentation areas are generated with the expansion of distinct seed elements.
- The resulting segmented parts are merged if they comply with certain geometric criteria.

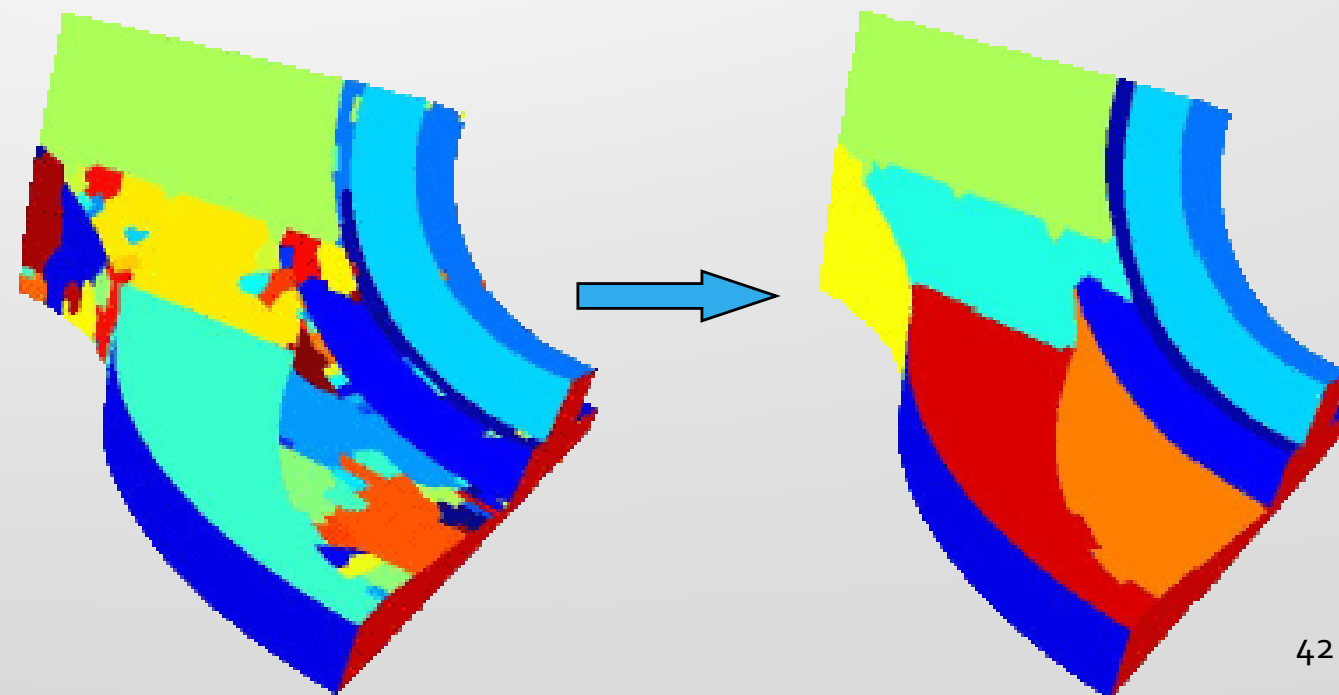
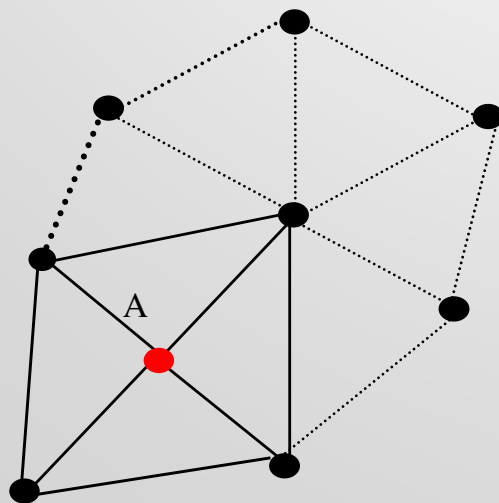

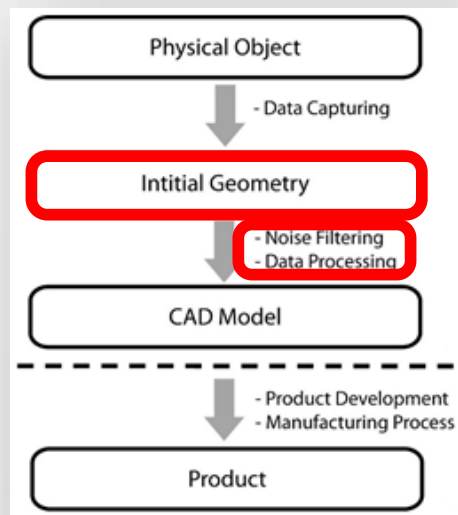

Data processing: segmentation cont.

- **Watershed methods¹³:** In this category segmentation is achieved in analogy to the way that water fills a geographic surface.
- For segmentation purposes, the watershed algorithm is not applied to the original 3D Mesh but it is applied to a transformed version based on a watershed function $f: R^3 \rightarrow R$
- There is a one-to-one correspondence between the minima of f and the catchment basins.

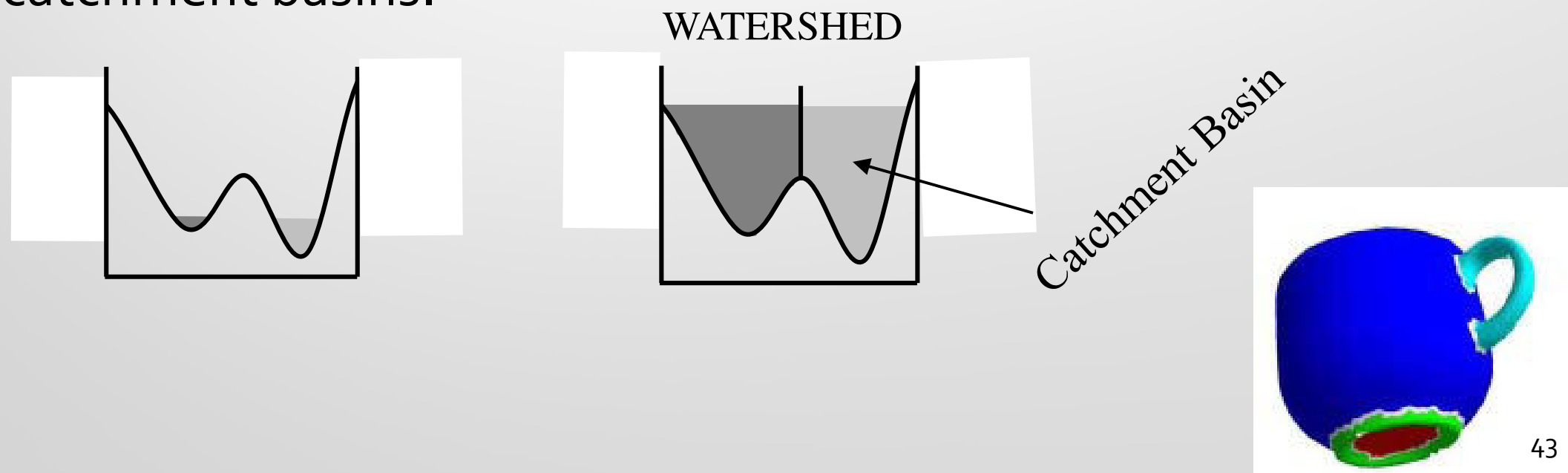

[13] Pulla, S.; Razdan, A.; Farin, G.: Improved curvature estimation for watershed segmentation of 3-dimensional meshes, IEEE Trans. Visualization and Computer Graphics, 2001.

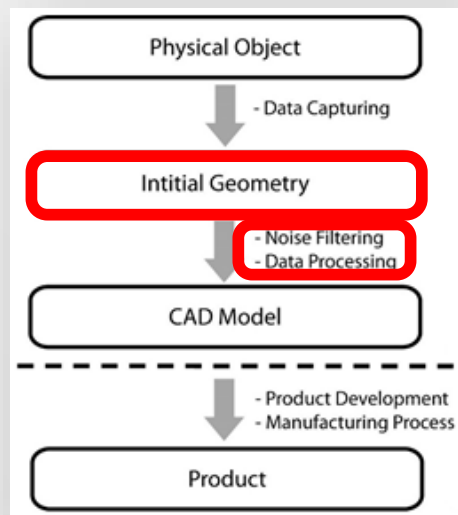

Data processing: segmentation cont.

- **Clustering¹⁴**: Segmentation is achieved either by an iterative clustering approach, where a k-means algorithm is applied, or by a hierarchy of cluster elements (triangles, points, etc.) approximated by a primitive (plane, sphere, etc.).
- The process relies on edge contraction in the mesh dual graph.

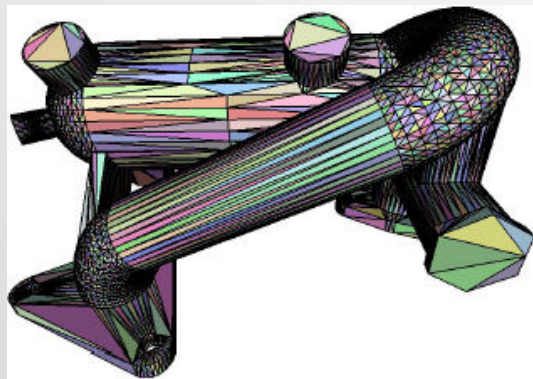

Original mesh

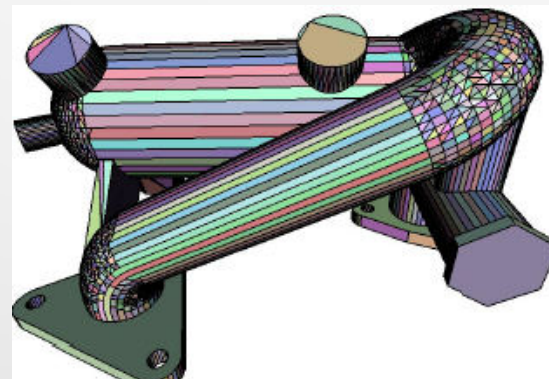

6000 clusters

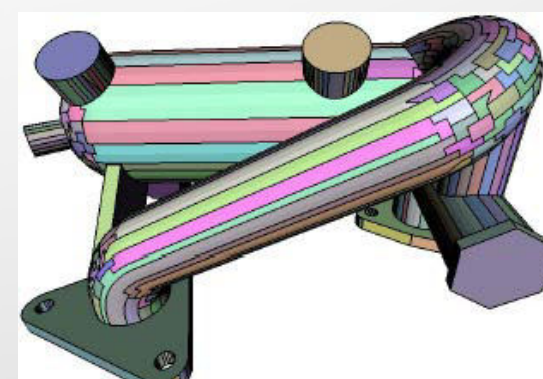

1000 clusters



2 clusters

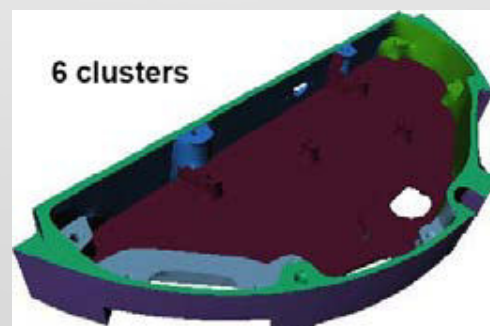

6 clusters

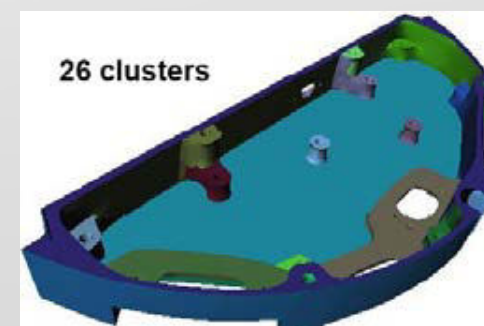

26 clusters

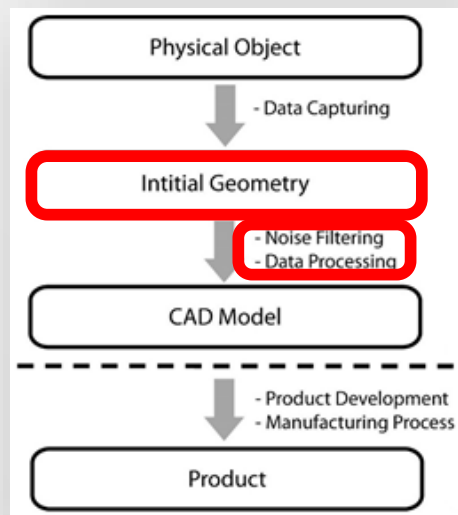

Data processing: segmentation cont.

- **Critical-Points Based¹⁵**: Algorithms that follow this method use critical points defined on the mesh to guide segmentation.
- These critical points are salient features of the 3D mesh and are used to aid the segmentation process to distinct between the different protrusions of the mesh.
- These algorithms are efficient in identifying the core part of an object.

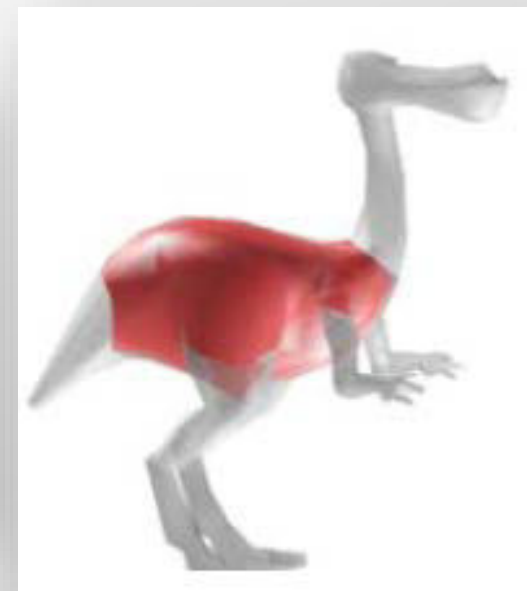
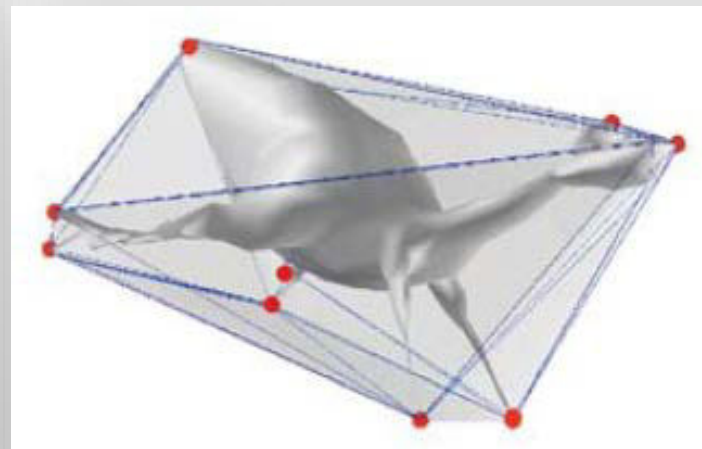

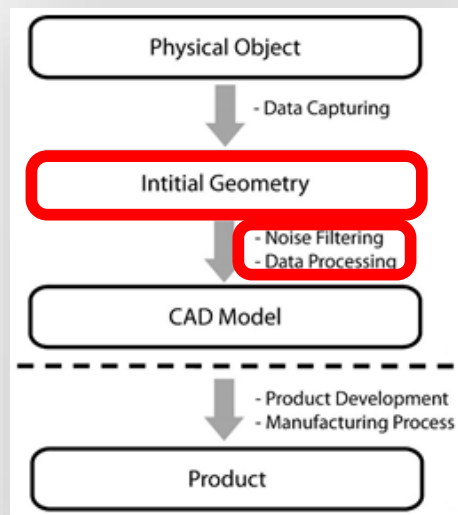

Data processing: segmentation cont.

- **Direct Segmentation¹⁶**: The CAD model is segmented into smaller regions where the 3D points belonging on sharp or various sort of smooth edges are disregarded. These regions are approximated by a hierarchy of surfaces.
- The hierarchy starts from simple surfaces like planes, spheres, cylinders, tori and move to more complicated ones like surfaces of linear extrusion and surfaces of revolution.

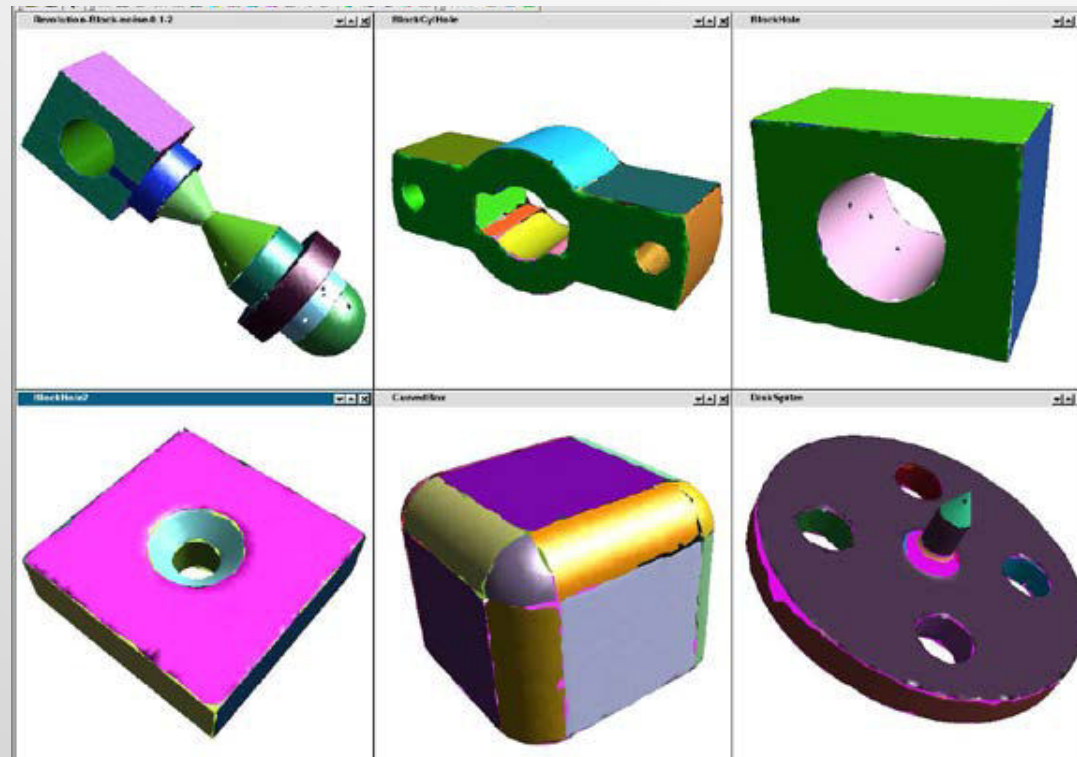

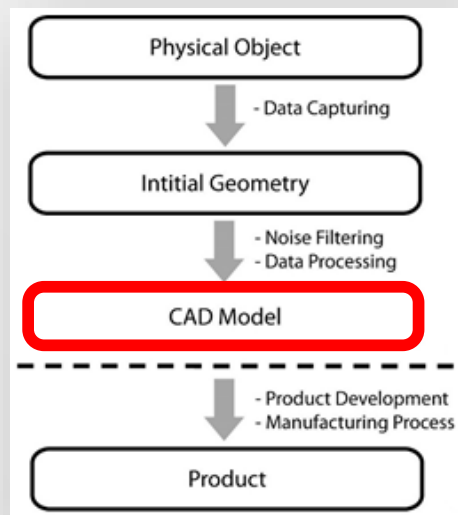

CAD Model

- The purpose of the last phase of RE is to construct smooth surface patches of the object surface that will be joined together with appropriate continuity conditions.
- The last phase requires user intervention as well.

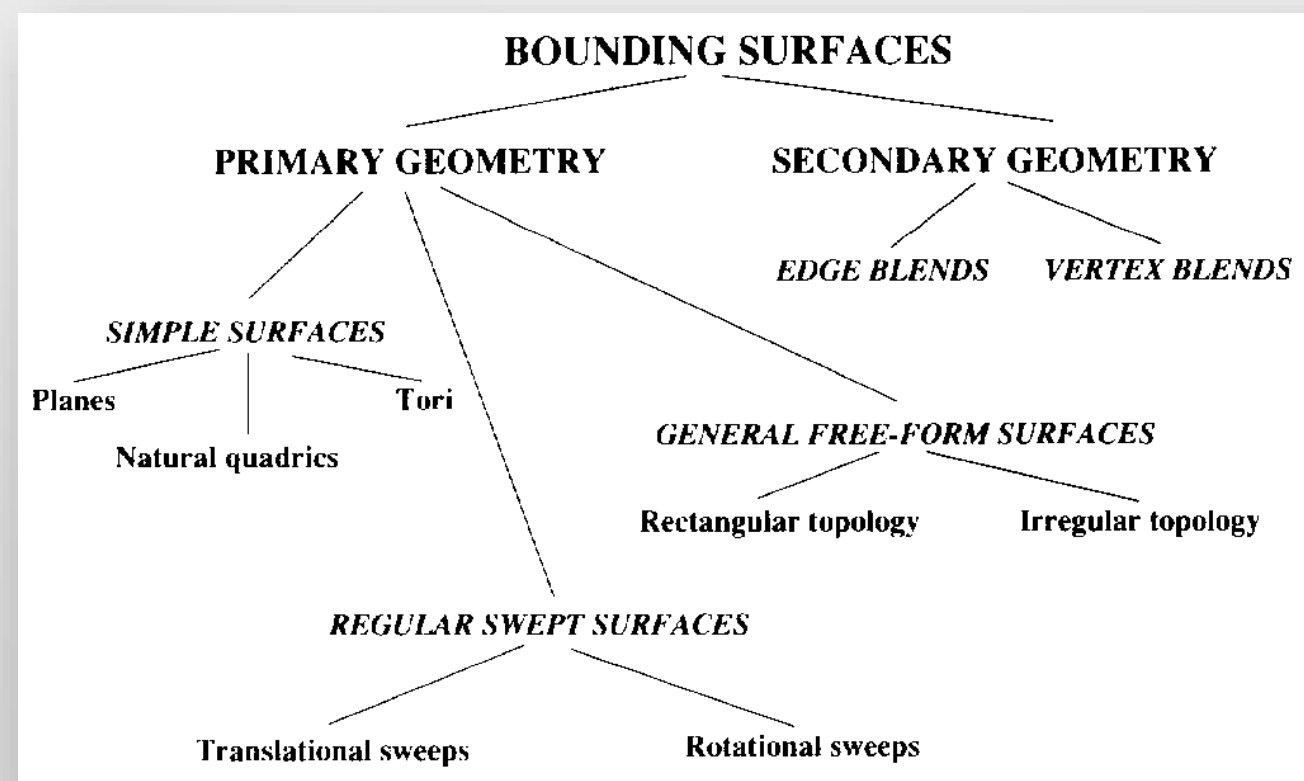

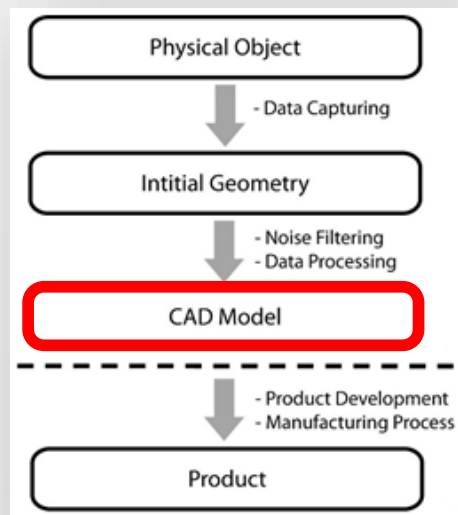

CAD Model cont.

- In surface fitting four main approaches are identified for free-form surface reconstruction:
 - Global approximating surfaces
 - Curve network based surfaces
 - Arbitrary topology surfaces
 - Functionally decomposed surfaces

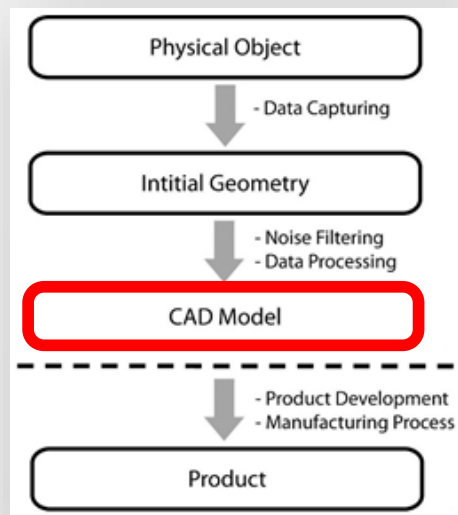

CAD Model cont.

- A note on Least-Squares Fitting for a set of points
 - Find the best-fit curve (or surface) that minimizes the sum of square distances between the curve (or surface) and the sample points.

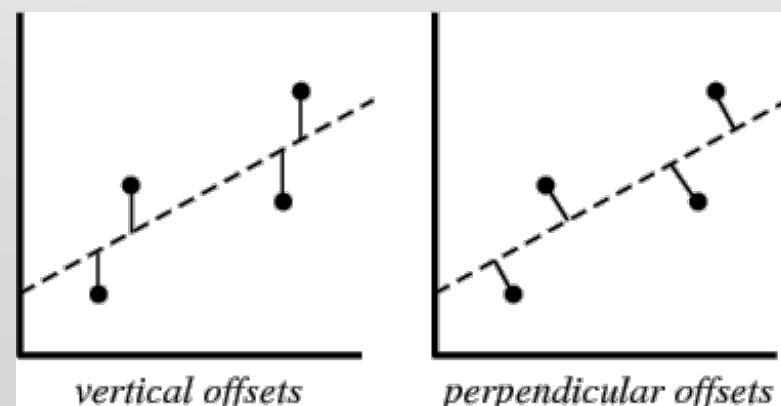
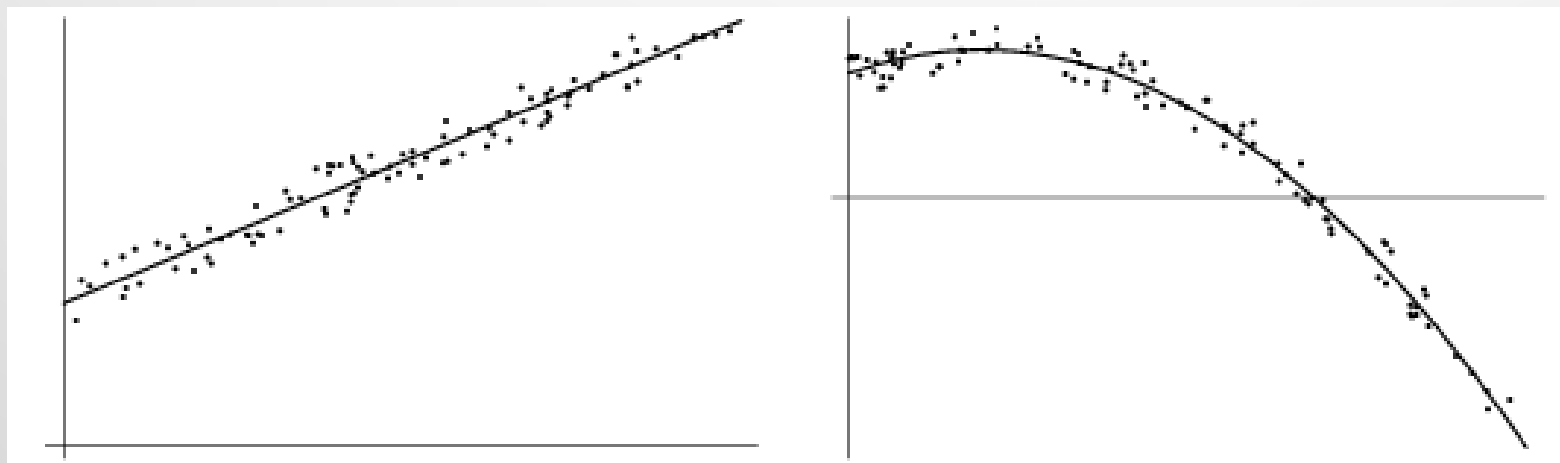

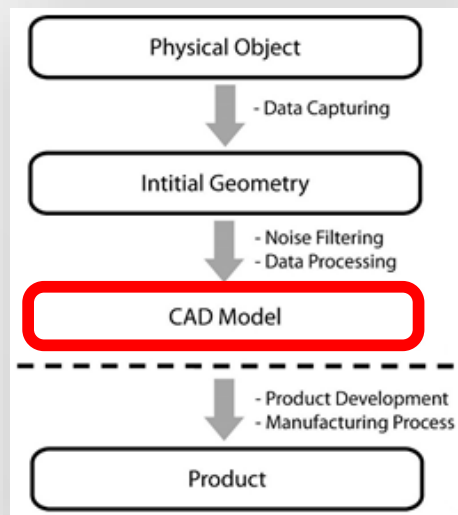

CAD Model cont.

- Global approximating surfaces¹⁷
 - A large roughly approximating surface is chosen in such a way that all points of interest lie within its boundaries.
 - The surface is fitted to the point-cloud in the Least Squares sense: the distance between all points with the surface is minimized.
 - If the distance of the points and the surface is above a predefined tolerance the procedure is iterated.
 - The final fit-surface is trimmed according to trimming curves defined along the object boundaries.

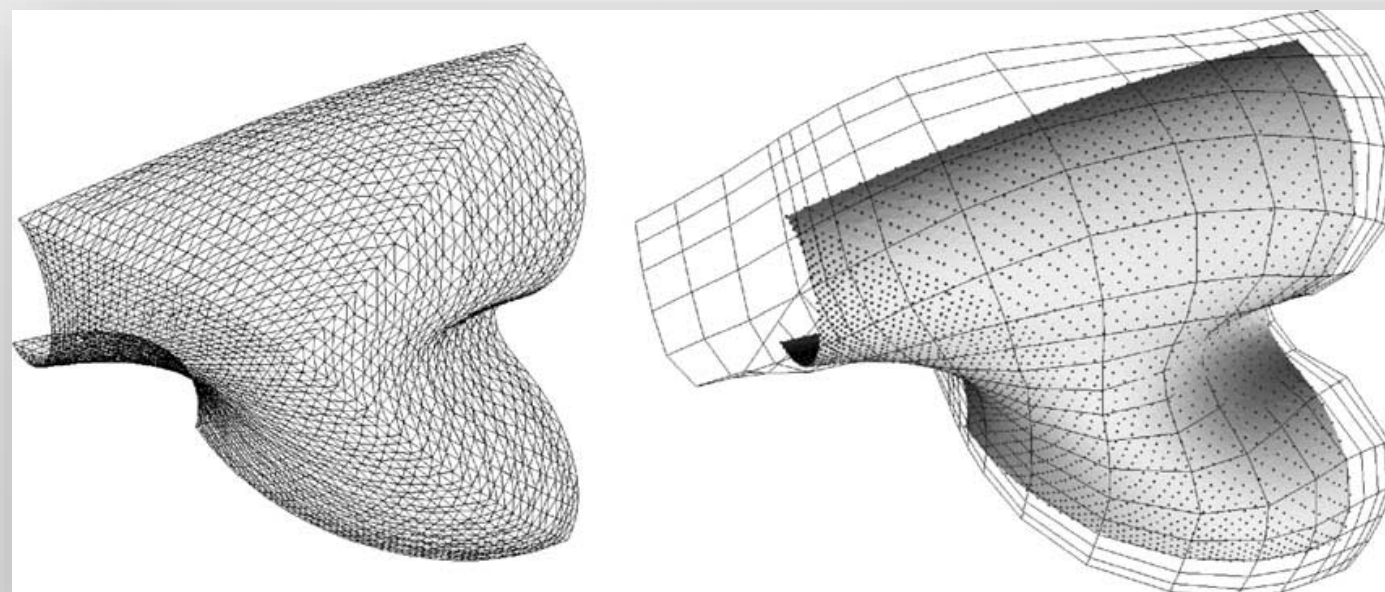

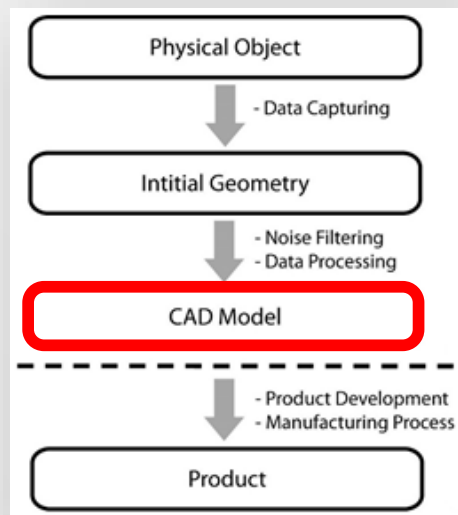

CAD Model cont.

- Curve network based surfaces
 - The object surfaces are divided by means of “characteristic curves” that express e.g., sharp edge boundaries, lines of extreme curvature, lines of symmetry, etc.
 - The phase of producing the curve network is semi-automatic, since it requires the user involvement to verify, modify, or amend the curve network that it is created by a system.
 - Also, the user can introduce more curves to reflect features of engineering importance.
 - The produced curve network usually has a rectangular topology (four-sided patches).
 - Modern systems allow the storage of curve networks as templates for future RE tasks.

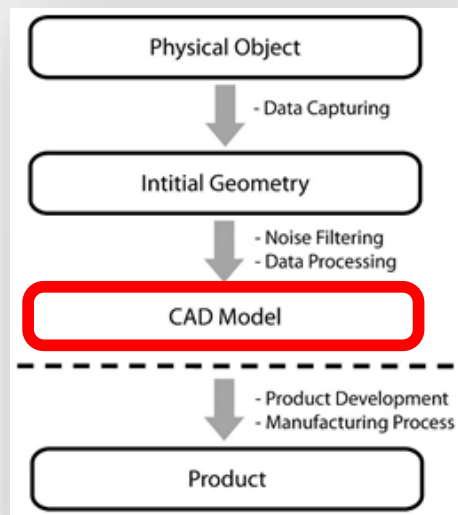

CAD Model cont.

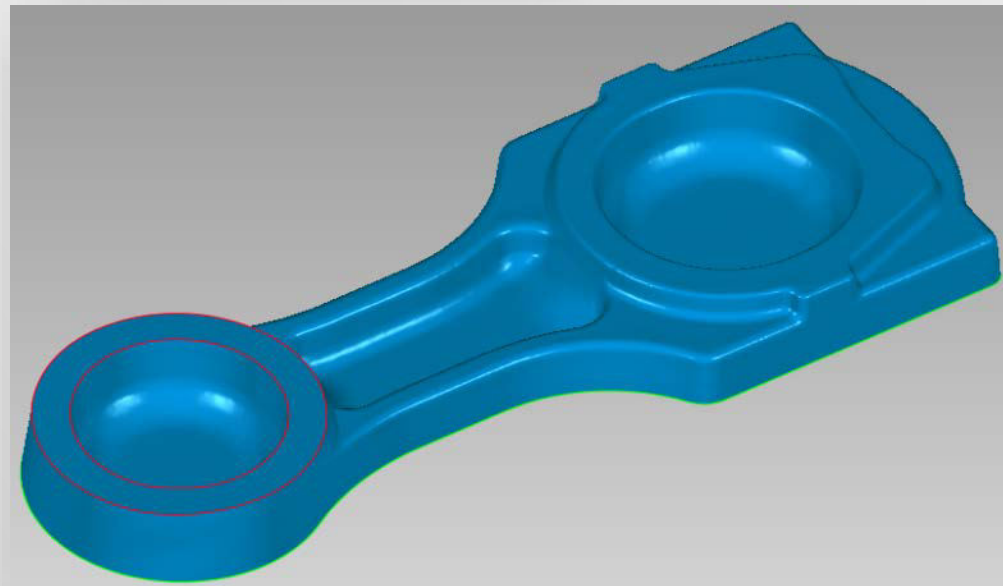

Initial triangulated surface
(748K triangles)

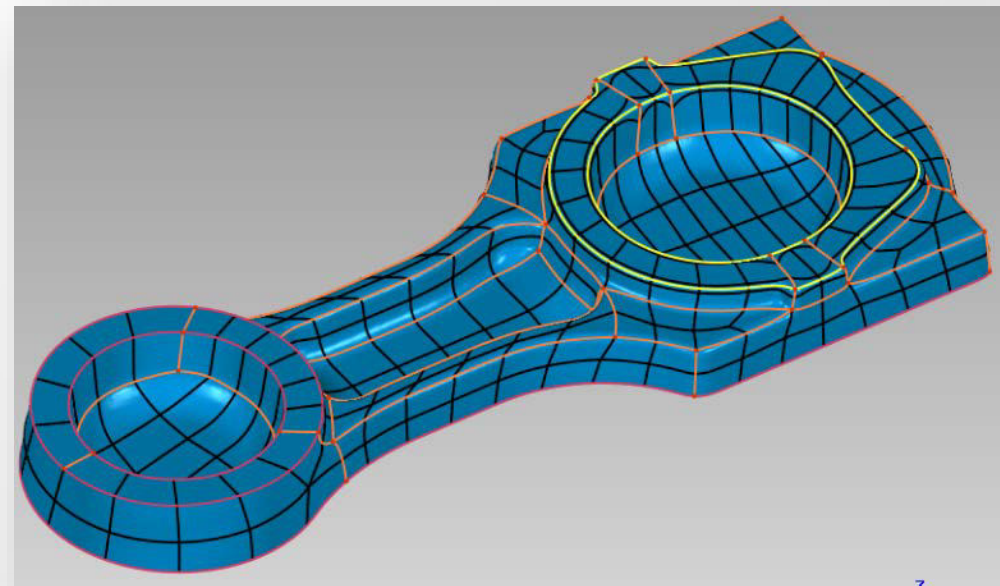

Curve network (485 patches
and 43 panels)

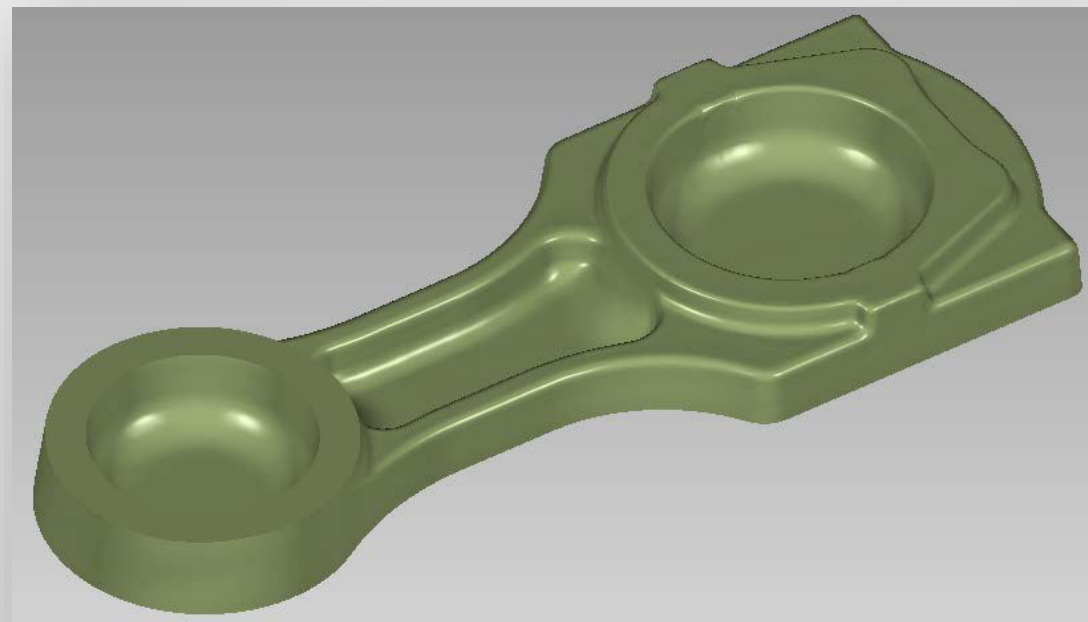

Final NURBS surface
(485 patches)

Complete RE example



The original object

Complete RE example

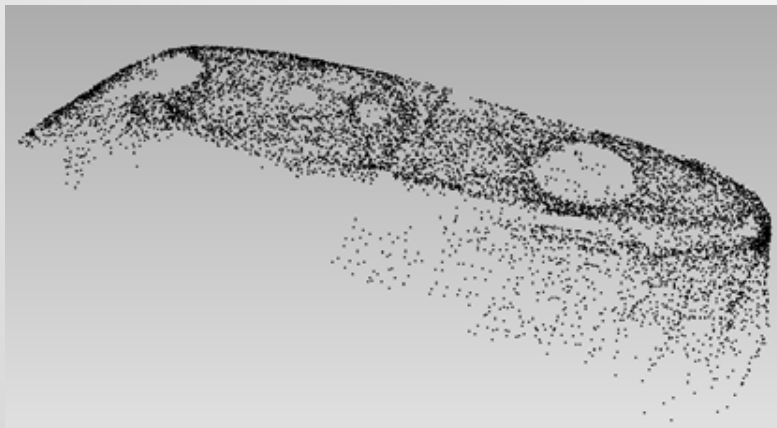
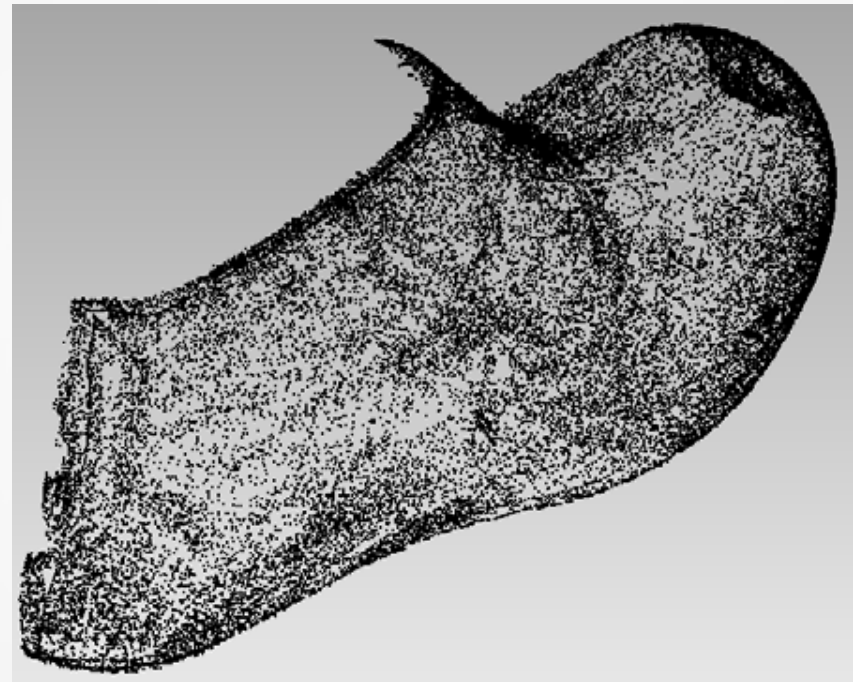

The four sides of the object surface are scanned using a Microscribe digitizer (~100k points are sampled).

Complete RE example

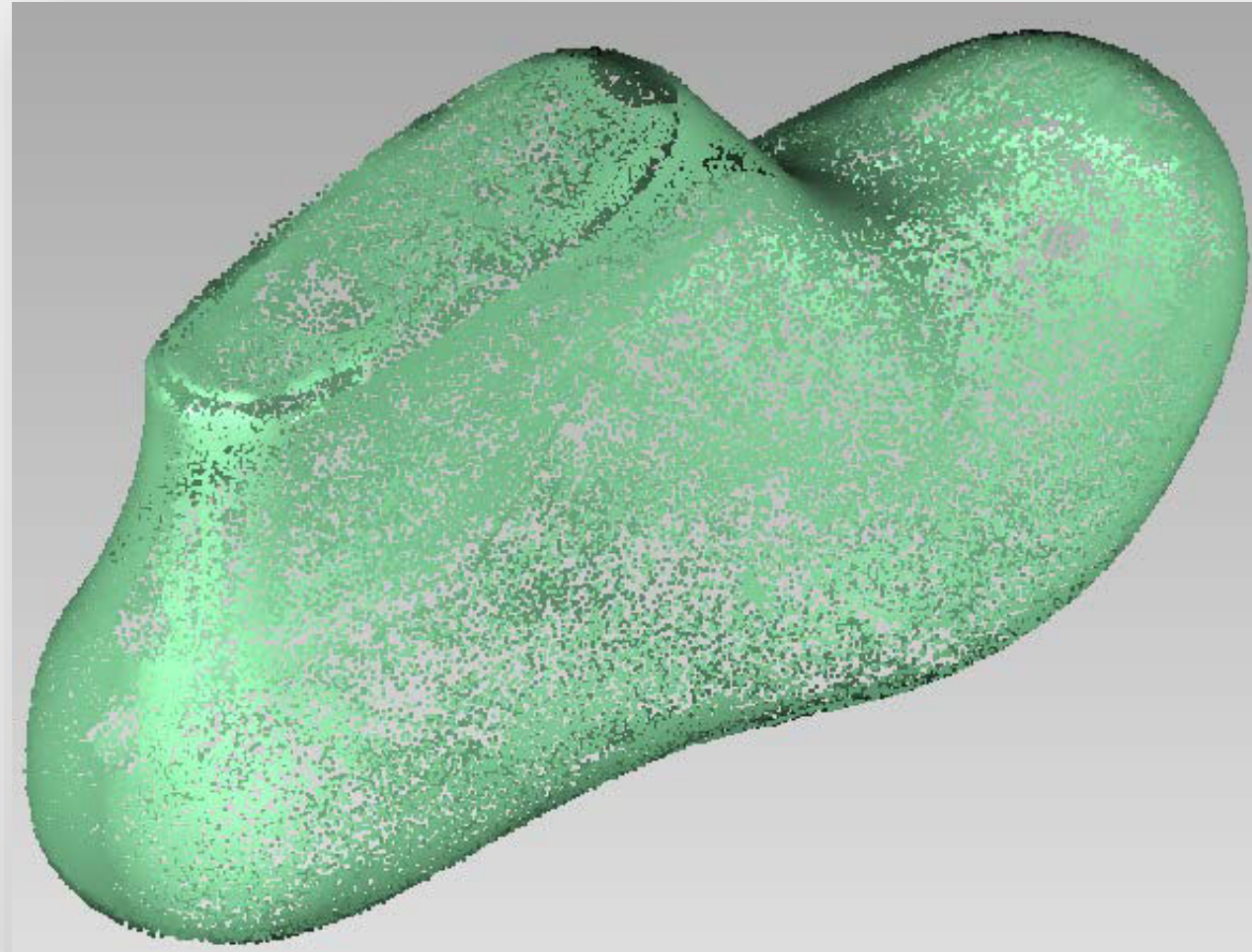

The initial point-cloud after merging all four sub-clouds and noise removal (~96K points).

Complete RE example



Triangulation of the point data

Complete RE example

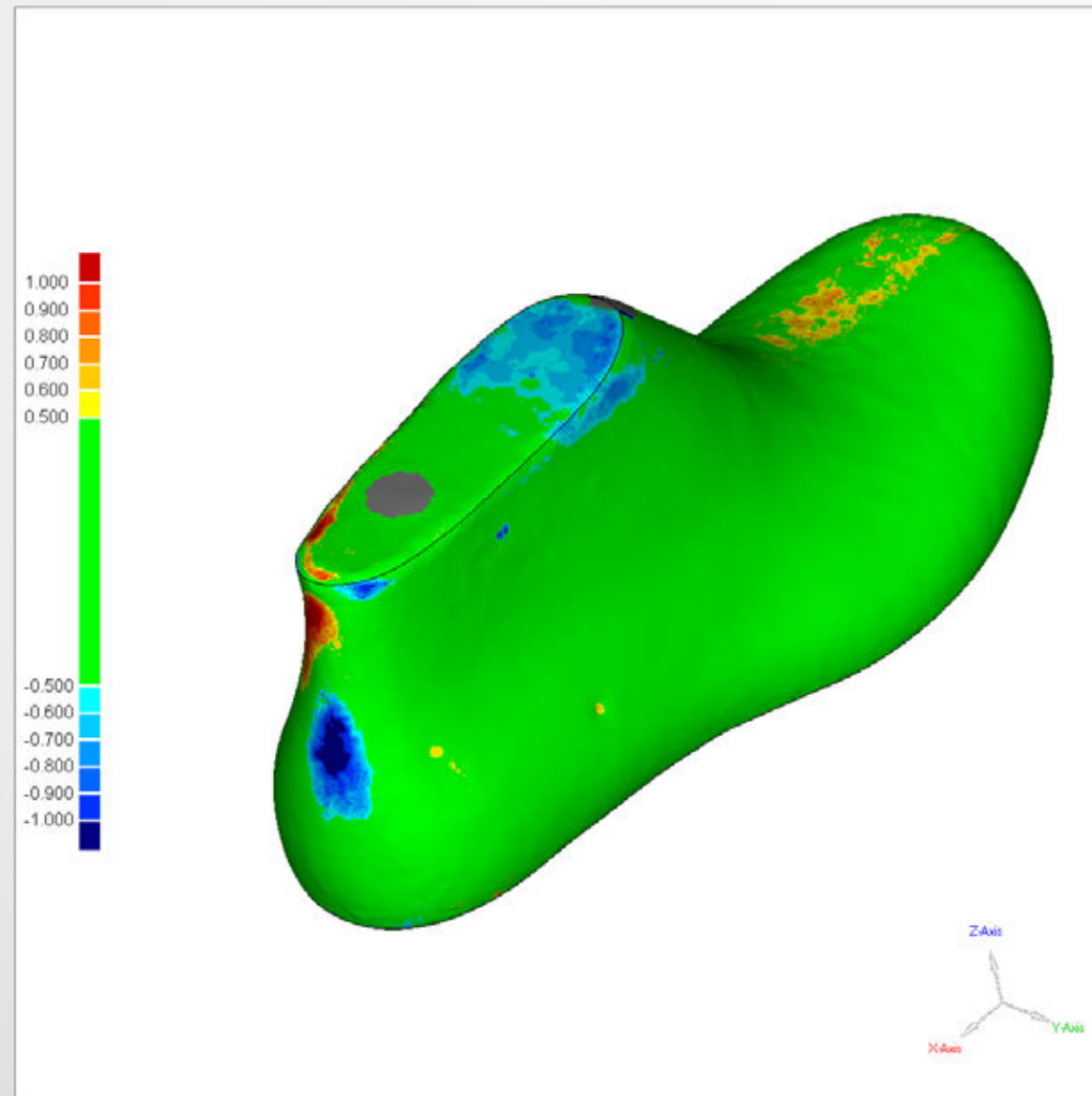

Comparison of the triangulated surface with the point-cloud reveals that the produced surface approximates the original data with 1 mm accuracy.

Complete RE example

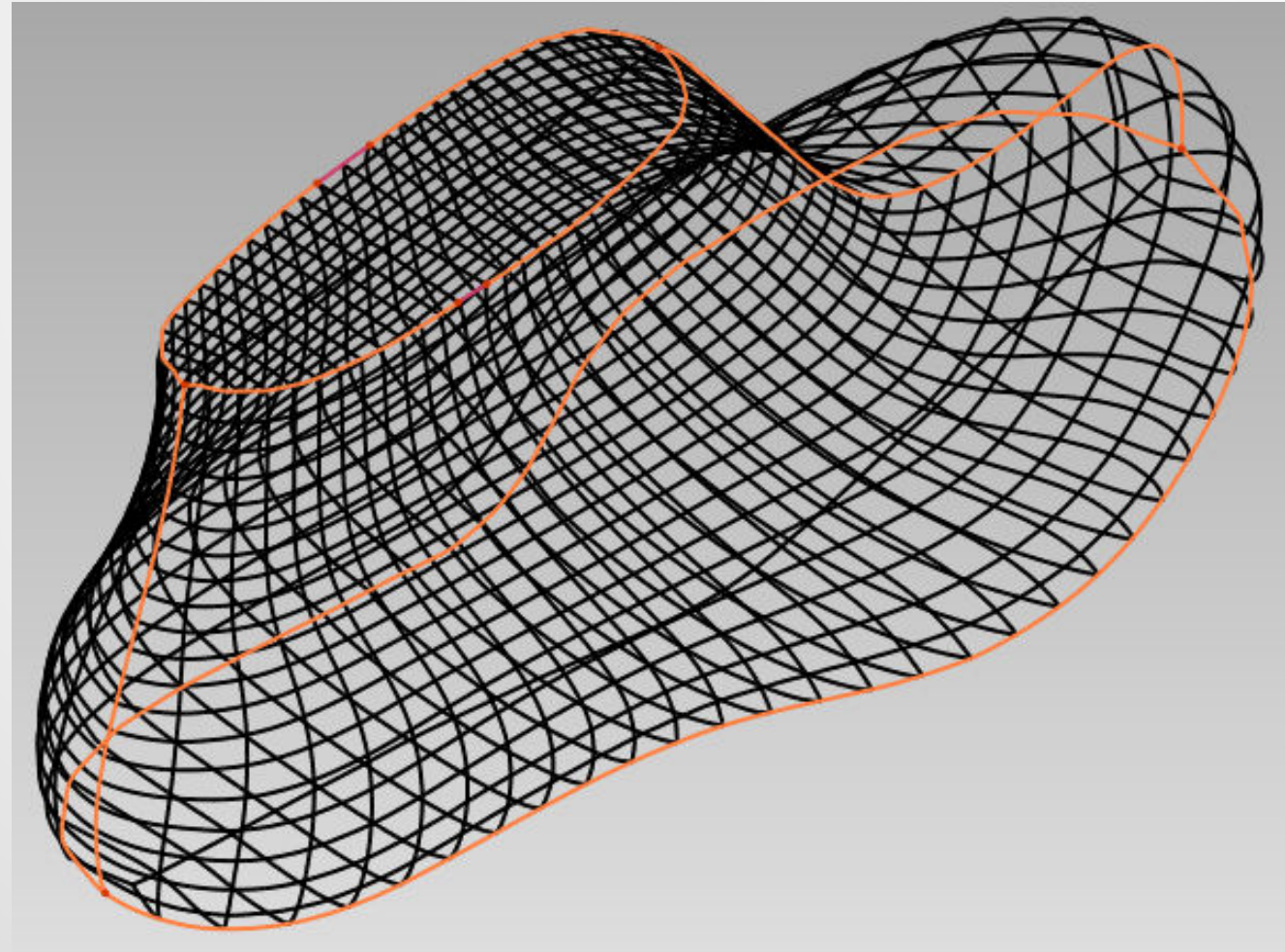

The curve network (which is also saved as a template for future use with similar objects)

Complete RE example

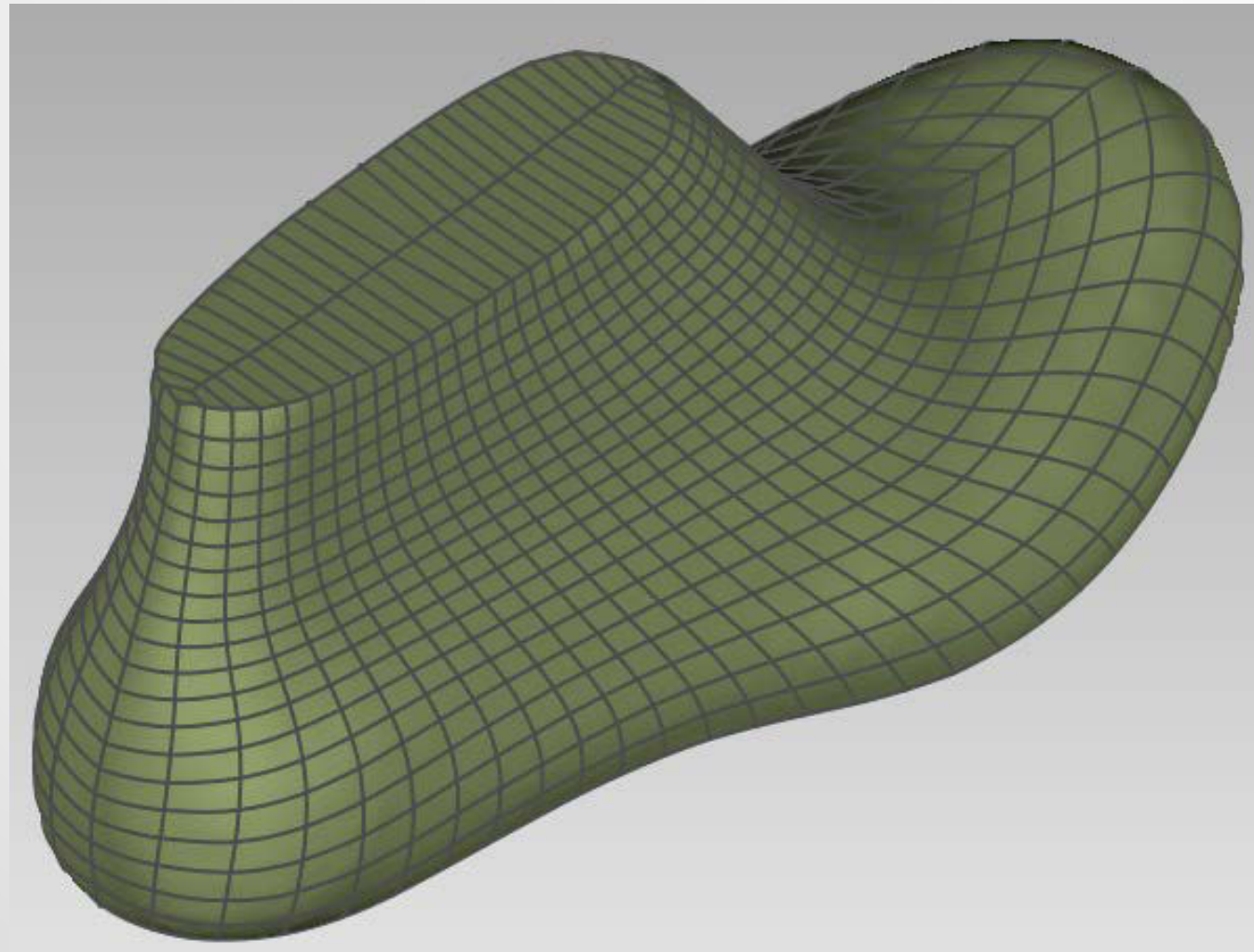

The final NURBS surface consists of ~1300 patches



- David SLS-2 Scanner tutorials:
 - <https://vimeo.com/122406223>
 - <https://vimeo.com/122406221>
 - <https://vimeo.com/122406220>
 - <https://www.youtube.com/watch?v=mtJxoi8YXKI>



- Creaform 3D scanners: Handyscan:

- https://youtu.be/yE_vsGAYC1w
- <https://www.youtube.com/watch?v=GcXPxHFFSk4>
- <https://youtu.be/4lY1IN8swEc>
- <https://www.youtube.com/watch?v=joO6NmiWmb4>